



X11SCQ/-L

USER'S MANUAL

Revision 1.0

The information in this user's manual has been carefully reviewed and is believed to be accurate. The vendor assumes no responsibility for any inaccuracies that may be contained in this document, and makes no commitment to update or to keep current the information in this manual, or to notify any person or organization of the updates. **Please Note: For the most up-to-date version of this manual, please see our website at www.supermicro.com.**

Super Micro Computer, Inc. ("Supermicro") reserves the right to make changes to the product described in this manual at any time and without notice. This product, including software and documentation, is the property of Supermicro and/or its licensors, and is supplied only under a license. Any use or reproduction of this product is not allowed, except as expressly permitted by the terms of said license.

IN NO EVENT WILL Super Micro Computer, Inc. BE LIABLE FOR DIRECT, INDIRECT, SPECIAL, INCIDENTAL, SPECULATIVE OR CONSEQUENTIAL DAMAGES ARISING FROM THE USE OR INABILITY TO USE THIS PRODUCT OR DOCUMENTATION, EVEN IF ADVISED OF THE POSSIBILITY OF SUCH DAMAGES. IN PARTICULAR, SUPER MICRO COMPUTER, INC. SHALL NOT HAVE LIABILITY FOR ANY HARDWARE, SOFTWARE, OR DATA STORED OR USED WITH THE PRODUCT, INCLUDING THE COSTS OF REPAIRING, REPLACING, INTEGRATING, INSTALLING OR RECOVERING SUCH HARDWARE, SOFTWARE, OR DATA.

Any disputes arising between manufacturer and customer shall be governed by the laws of Santa Clara County in the State of California, USA. The State of California, County of Santa Clara shall be the exclusive venue for the resolution of any such disputes. Supermicro's total liability for all claims will not exceed the price paid for the hardware product.

FCC Statement: This equipment has been tested and found to comply with the limits for a Class B digital device pursuant to Part 15 of the FCC Rules. These limits are designed to provide reasonable protection against harmful interference when the equipment is operated in a commercial environment. This equipment generates, uses, and can radiate radio frequency energy and, if not installed and used in accordance with the manufacturer's instruction manual, may cause harmful interference with radio communications. Operation of this equipment in a residential area is likely to cause harmful interference, in which case you will be required to correct the interference at your own expense.

California Best Management Practices Regulations for Perchlorate Materials: This Perchlorate warning applies only to products containing CR (Manganese Dioxide) Lithium coin cells. "Perchlorate Material-special handling may apply. See www.dtsc.ca.gov/hazardouswaste/perchlorate".



WARNING: This product can expose you to chemicals including lead, known to the State of California to cause cancer and birth defects or other reproductive harm. For more information, go to www.P65Warnings.ca.gov.

The products sold by Supermicro are not intended for and will not be used in life support systems, medical equipment, nuclear facilities or systems, aircraft, aircraft devices, aircraft/emergency communication devices or other critical systems whose failure to perform be reasonably expected to result in significant injury or loss of life or catastrophic property damage. Accordingly, Supermicro disclaims any and all liability, and should buyer use or sell such products for use in such ultra-hazardous applications, it does so entirely at its own risk. Furthermore, buyer agrees to fully indemnify, defend and hold Supermicro harmless for and against any and all claims, demands, actions, litigation, and proceedings of any kind arising out of or related to such ultra-hazardous use or sale.

Manual Revision 1.0

Release Date: September 10, 2018

Unless you request and receive written permission from Super Micro Computer, Inc., you may not copy any part of this document. Information in this document is subject to change without notice. Other products and companies referred to herein are trademarks or registered trademarks of their respective companies or mark holders.

Copyright © 2018 by Super Micro Computer, Inc.

All rights reserved.

Printed in the United States of America

Preface

About This Manual

This manual is written for system integrators, IT technicians, and knowledgeable end users. It provides information for the installation and use of the X11SCQ/-L motherboard.

About This Motherboard

The X11SCQ/-L motherboard supports an Intel 8th Gen Core i3/i5/i7, Pentium, or Celeron processor in an LGA1151 socket. The X11SCQ/-L provides maximum performance with the latest Intel CPU architecture, up to 32 or 64GB DDR4-2666 memory, HDMI 2.0, DisplayPort, DVI-D, M.2, dual Gigabit LAN, USB 3.1 Gen 1/2, PCI-E 3.0 x16 expandability, and is optimized for medical, surveillance, digital signage, DVR/NVR, POS, and office server applications. Please note that this motherboard is intended to be installed and serviced by professional technicians only. For processor and memory updates, please refer to our website at <http://www.supermicro.com/products/>.

Manual Organization

Chapter 1 describes the features, specifications and performance of the motherboard, and provides detailed information on the Q370/H310 chipset.

Chapter 2 provides hardware installation instructions. Read this chapter when installing the processor, memory modules, and other hardware components into the system.

If you encounter any problems, see **Chapter 3**, which describes troubleshooting procedures for video, memory, and system setup stored in the CMOS.

Chapter 4 includes an introduction to the BIOS, and provides detailed information on running the CMOS Setup utility.

Appendix A provides BIOS Error Beep Codes.

Appendix B lists software program installation instructions.

Appendix C lists standardized warning statements in various languages.

Appendix D provides UEFI BIOS Recovery instructions.

Contacting Supermicro

Headquarters

Address: Super Micro Computer, Inc.
980 Rock Ave.
San Jose, CA 95131 U.S.A.

Tel: +1 (408) 503-8000

Fax: +1 (408) 503-8008

Email: marketing@supermicro.com (General Information)
support@supermicro.com (Technical Support)

Website: www.supermicro.com

Europe

Address: Super Micro Computer B.V.
Het Sterrenbeeld 28, 5215 ML
's-Hertogenbosch, The Netherlands

Tel: +31 (0) 73-6400390

Fax: +31 (0) 73-6416525

Email: sales@supermicro.nl (General Information)
support@supermicro.nl (Technical Support)
rma@supermicro.nl (Customer Support)

Website: www.supermicro.nl

Asia-Pacific

Address: Super Micro Computer, Inc.
3F, No. 150, Jian 1st Rd.
Zhonghe Dist., New Taipei City 235
Taiwan (R.O.C)

Tel: +886-(2) 8226-3990

Fax: +886-(2) 8226-3992

Email: support@supermicro.com.tw

Website: www.supermicro.com.tw

Table of Contents

Chapter 1 Introduction

1.1 Checklist	8
Quick Reference Table	12
Motherboard Features	14
1.2 Processor and Chipset Overview	18
1.3 Special Features	18
Recovery from AC Power Loss	18
1.4 System Health Monitoring	19
Onboard Voltage Monitors	19
Fan Status Monitor with Firmware Control	19
Environmental Temperature Control	19
System Resource Alert	19
1.5 ACPI Features	20
1.6 Power Supply	20
1.7 Super I/O	20

Chapter 2 Installation

2.1 Static-Sensitive Devices	21
Precautions	21
Unpacking	21
2.2 Motherboard Installation	22
Tools Needed	22
Location of Mounting Holes	22
Installing the Motherboard	23
2.3 Processor and Heatsink Installation	24
Installing the LGA1151 Processor	24
Installing an Active CPU Heatsink with Fan	26
Removing the Heatsink	28
2.4 Memory Support and Installation	29
Memory Support	29
DIMM Module Population Configuration	29
DIMM Module Population Sequence	29
DIMM Installation	30

DIMM Removal	30
2.5 Rear I/O Ports	31
2.6 Front Control Panel	36
2.7 Connectors	40
2.8 Jumper Settings	51
How Jumpers Work	51
2.9 LED Indicators	56
Chapter 3 Troubleshooting	
3.1 Troubleshooting Procedures	57
Before Power On	57
No Power	57
No Video	58
System Boot Failure	58
Memory Errors	58
Losing the System's Setup Configuration	59
When the System Becomes Unstable	59
3.2 Technical Support Procedures	61
3.3 Frequently Asked Questions	62
3.4 Battery Removal and Installation	63
Battery Removal	63
Proper Battery Disposal	63
Battery Installation	63
3.5 Returning Merchandise for Service	64
Chapter 4 BIOS	
4.1 Introduction	65
Starting the Setup Utility	65
4.2 Main Setup	66
4.3 Advanced	68
4.4 Event Logs	100
4.5 Security	102
4.7 Boot	106
4.8 Save & Exit	109

Appendix A BIOS CodesA.1 BIOS Error POST (Beep) Codes 111**Appendix B Software Installation**B.1 Installing Software Programs 113B.2 SuperDoctor® 5..... 114**Appendix C Standardized Warning Statements****Appendix D UEFI BIOS Recovery**

Chapter 1

Introduction

Congratulations on purchasing your computer motherboard from an acknowledged leader in the industry. Supermicro boards are designed with the utmost attention to detail to provide you with the highest standards in quality and performance.

Please check that the following items have all been included with your motherboard. If anything listed here is damaged or missing, contact your retailer. The following items are included in the retail box:

1.1 Checklist

Main Parts List (included in the retail box)		
Description	Part Number	Quantity
Supermicro motherboard X11SCQ/-L	MBD-X11SCQ/-L	1
SATA cables (for X11SCQ)	CBL-0044L	6
SATA cables (for X11SCQ-L)	CBL-0044L	4
I/O Shield	MCP-260-00125-0N	1
Quick Reference Guide	MNL-2110-QRG	1

Important Links

For your system to work properly, please follow the links below to download all necessary drivers/utilities and the user's manual for your server.

- Supermicro product manuals: <http://www.supermicro.com/support/manuals/>
- Product drivers and utilities: <https://www.supermicro.com/wftp/driver/>
- Product safety info: http://www.supermicro.com/about/policies/safety_information.cfm
- If you have any questions, please contact our support team at: support@supermicro.com

This manual may be periodically updated without notice. Please check the Supermicro website for possible updates to the manual revision level.

Figure 1-1. X11SCQ Motherboard Image

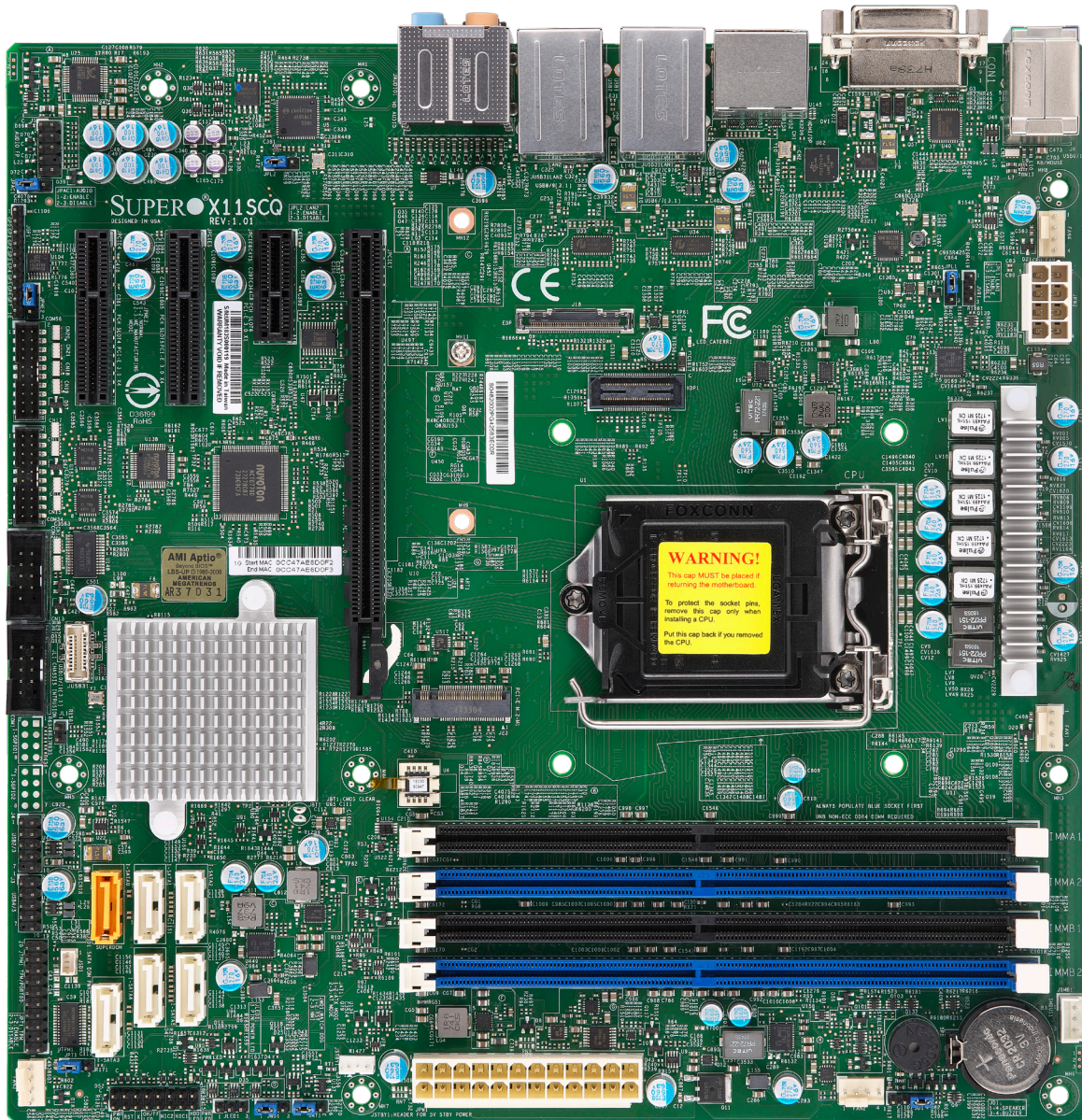

Note: All graphics shown in this manual were based upon the latest PCB revision available at the time of publication of the manual. The motherboard you received may or may not look exactly the same as the graphics shown in this manual.

Figure 1-2. X11SCQ-L Motherboard Image

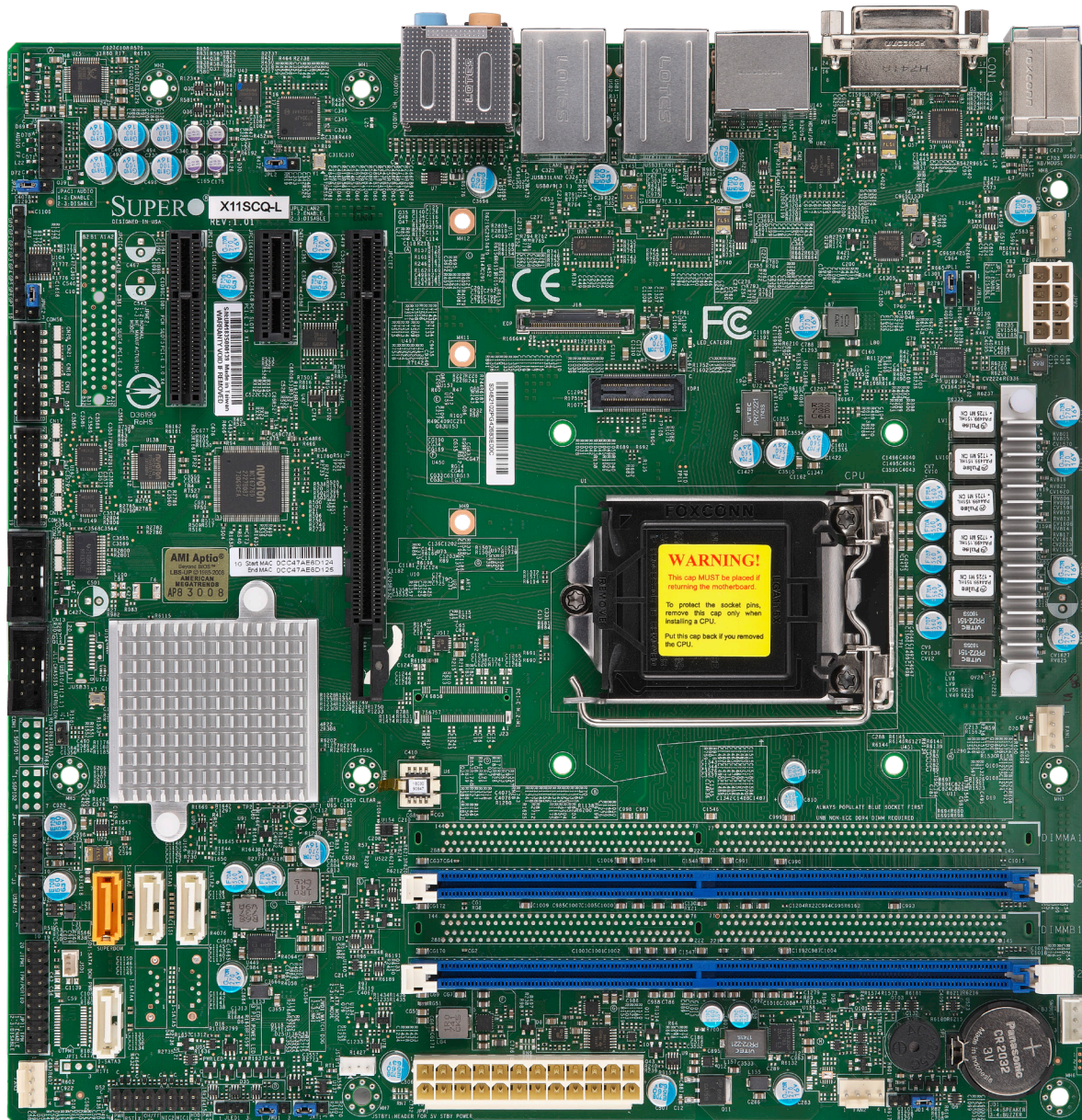

**Figure 1-3. X11SCQ/-L Motherboard Layout
(not drawn to scale)**

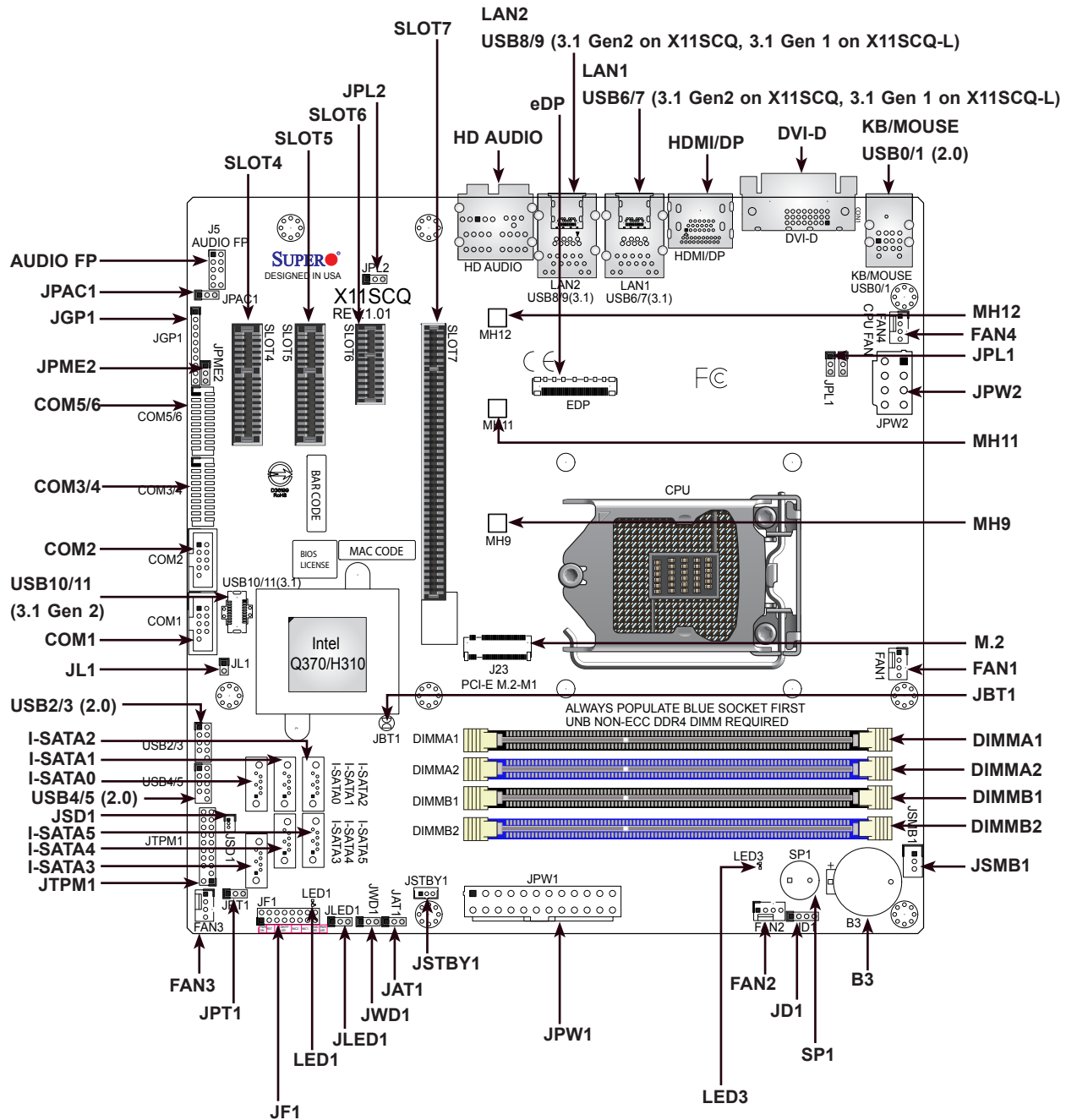

Notes:

- USB 3.1 Gen 1 is also referred to as USB 3.0.
- See Chapter 2 for detailed information on jumpers, I/O ports, and JF1 front panel connections. Jumpers/components/LED indicators not indicated are used for internal testing only.
- "■" indicates the location of Pin 1.
- Use only the correct type of onboard CMOS battery as specified by the manufacturer. Do not install the onboard battery upside down to avoid possible explosion.

Quick Reference Table

Jumper	Description	Default Setting
JAT1	ATX/AT Mode	Pins 1-2 (ATX Mode)
JBT1	CMOS Clear	Open (Normal)
JPAC1	Audio Enable	Pins 1-2 (Enable)
JPL1, JPL2	LAN1/LAN2 Enable/Disable	Pins 1-2 (Enable)
JPME2	Manufacturing Mode	Pins 1-2 (Normal)
JPT1	Onboard TPM Enable/Disable (not available on X11SCQ-L)	Pins 1-2 (Enable)
JWD1	Watch Dog Timer	Pins 1-2 (Reset)

Connector	Description
AUDIO FP	Front Panel Audio Header
B3	Onboard Battery
COM1	COM1 Header
COM2	COM2 Header
COM3/4	COM3 and COM4 Headers
COM5/6	COM5 and COM6 Headers
DVI-D	Digital Visual Interface Port (Digital only)
eDP	Embedded DisplayPort
FAN1 - FAN4	CPU/System Fan Headers (FAN4: CPU Fan)
HD AUDIO	Rear Audio Ports
HDMI/DP	High Definition Multimedia Interface/DisplayPort
I-SATA0 - I-SATA5	SATA 3.0 Ports (SATA4 and SATA5 are not available on X11SCQ-L)
JD1	Speaker/Buzzer (Pins 1-4: Speaker, Pins 3-4: Buzzer)
JF1	Front Control Panel Header
JGP1	General Purpose I/O Header
JL1	Chassis Intrusion Header
JLED1	3-pin Power LED Indicator Header
JPW1	24-pin ATX Main Power Connector (Required)
JPW2	+12V 8-pin CPU Power Connector (Required)
JSD1	SATA DOM Power Header
JSMB1	System Management Bus Header
JSTBY1	5V Standby Power Header
JTPM1	Trusted Platform Module (TPM)/Port 80 Header
KB/MOUSE	Keyboard and Mouse Connector
LAN1, LAN2	Gigabit Ethernet (RJ45) Port
M.2	M.2 M-Key PCIE3 Connector (not available on X11SCQ-L)



Note: The table above is continued on the next page.

Connector	Description
MH9, MH11, MH12	M.2 Mounting screws
SLOT4	PCI-E 3.0 x4 Slot (not available on X11SCQ-L)
SLOT5	PCI-E 3.0 x4 Slot (PCI-E 2.0 x4 on X11SCQ-L)
SLOT6	PCI-E 3.0 x1 Slot (PCI-E 2.0 x1 on X11SCQ-L)
SLOT7	PCI-E 3.0 x16 Slot
SP1	Speaker/Buzzer
USB0/1	Back Panel USB 2.0 Ports
USB2/3, USB4/5	Front Accessible USB 2.0 Headers
USB6/7, USB8/9	Back Panel USB 3.1 Gen 2 Ports (USB 3.1 Gen 1 on X11SCQ-L)
USB10/11	Front Accessible USB 3.1 Gen 2 Headers (not available on X11SCQ-L)
* USB 3.1 Gen 1 is also referred to as USB 3.0	

LED	Description	Status
LED1	Power LED	Solid Green: Power On
LED3	Standby Power LED	Green: Standby Power On

Motherboard Features

Motherboard Features					
CPU					
<ul style="list-style-type: none"> Supports an Intel 8th Gen Core i3/i5/i7, Pentium, Celeron processor in an LGA1151 socket. 					
Memory					
<ul style="list-style-type: none"> X11SCQ: Supports up to 64GB of DDR4 Non-ECC UDIMM with speeds of up to 2666MHz in four slots. X11SCQ-L: Supports up to 32GB of DDR4 Non-ECC UDIMM with speeds of up to 2666MHz in two slots. 					
DIMM Size					
<ul style="list-style-type: none"> 4GB, 8GB, 16GB 					
 Note 1: Refer to the motherboard product page for the list of supported memory.					
Chipset					
<ul style="list-style-type: none"> X11SCQ: Intel Q370 X11SCQ-L: Intel H310 					
Expansion Slots					
<table border="0"> <tr> <td style="text-align: center;">X11SCQ</td> <td style="text-align: center;">X11SCQ-L</td> </tr> <tr> <td> <ul style="list-style-type: none"> One (1) PCI-E 3.0 x16 Slot One (1) PCI-E 3.0 x1 Slot Two (2) PCI-E 3.0 x4 Slots </td> <td> <ul style="list-style-type: none"> One (1) PCI-E 3.0 x16 Slot One (1) PCI-E 2.0 x1 Slot One (1) PCI-E 2.0 x4 Slot </td> </tr> </table>	X11SCQ	X11SCQ-L	<ul style="list-style-type: none"> One (1) PCI-E 3.0 x16 Slot One (1) PCI-E 3.0 x1 Slot Two (2) PCI-E 3.0 x4 Slots 	<ul style="list-style-type: none"> One (1) PCI-E 3.0 x16 Slot One (1) PCI-E 2.0 x1 Slot One (1) PCI-E 2.0 x4 Slot 	
X11SCQ	X11SCQ-L				
<ul style="list-style-type: none"> One (1) PCI-E 3.0 x16 Slot One (1) PCI-E 3.0 x1 Slot Two (2) PCI-E 3.0 x4 Slots 	<ul style="list-style-type: none"> One (1) PCI-E 3.0 x16 Slot One (1) PCI-E 2.0 x1 Slot One (1) PCI-E 2.0 x4 Slot 				
Network Controller					
<ul style="list-style-type: none"> Intel I219LM Intel I210AT 					
Graphics					
<ul style="list-style-type: none"> Intel® UHD Graphics 					
I/O Devices					
<ul style="list-style-type: none"> COM Headers 	<ul style="list-style-type: none"> Six (6) COM ports in four headers 				
<ul style="list-style-type: none"> SATA 3.0 	<ul style="list-style-type: none"> X11SCQ: Six (6) SATA3.0 ports X11SCQ-L: Four (4) SATA 3.0 ports 				
<ul style="list-style-type: none"> Video ports 	<ul style="list-style-type: none"> DVI-D, DisplayPort, eDP, HDMI 2.0 				
<ul style="list-style-type: none"> Audio 	<ul style="list-style-type: none"> High-Definition Audio Connector 				
Peripheral Devices					
<ul style="list-style-type: none"> Four (4) USB 2.0 ports in two internal headers (USB2/3, USB4/5) Four (4) USB 3.1 ports, two Type-A and two Type-C, on the I/O back panel (USB6/7, USB8/9 - Gen 2 on X11SCQ, Gen 1 on X11SCQ-L) Two (2) USB 2.0 ports on the I/O back panel (USB0/1) Two (2) USB 3.1 Gen 2 ports in one internal header (USB10/11) [not available on X11SCQ-L] 					



Note: The table above is continued on the next page.

Motherboard Features
<p>BIOS</p> <ul style="list-style-type: none"> • 256Mb SPI AMI BIOS® SM Flash UEFI BIOS • ACPI 6.1, SMBIOS 3.1, UEFI 2.6 specification, PCI F/W 3.0, Plug-and-Play (PnP), SPI dual/quad speed support, RTC wakeup
<p>Power Management</p> <ul style="list-style-type: none"> • Power button override mechanism • Management Engine (ME) • Power-on mode for AC recovery • Keyboard wakeup from S5
<p>System Health Monitoring</p> <ul style="list-style-type: none"> • Onboard voltage monitoring for +12V, +3.3V, +5V, VDIMM (1.2V), Vcore (CPU), VBAT • 5+2 CPU switching phase voltage regulator • CPU Thermal Trip support
<p>System Management</p> <ul style="list-style-type: none"> • Trusted Platform Module (TPM) support • PECI (Platform Environment Control Interface) 2.0 support • System resource alert via SuperDoctor® 5 • Watch Dog, NMI
<p>LED Indicators</p> <ul style="list-style-type: none"> • CPU/System Overheat LED • Power/Suspend-state indicator LED • Fan Fail LED • HDD Activity LED • LAN Activity LED
<p>Dimensions</p> <ul style="list-style-type: none"> • 9.6" (L) x 9.6" (W) (24.38 cm x 24.38 cm)



Note 1: The CPU maximum thermal design power (TDP) is subject to chassis and heatsink cooling restrictions. For proper thermal management, please check the chassis and heatsink specifications for proper CPU TDP sizing.

Figure 1-4.
X11SCQ System Block Diagram

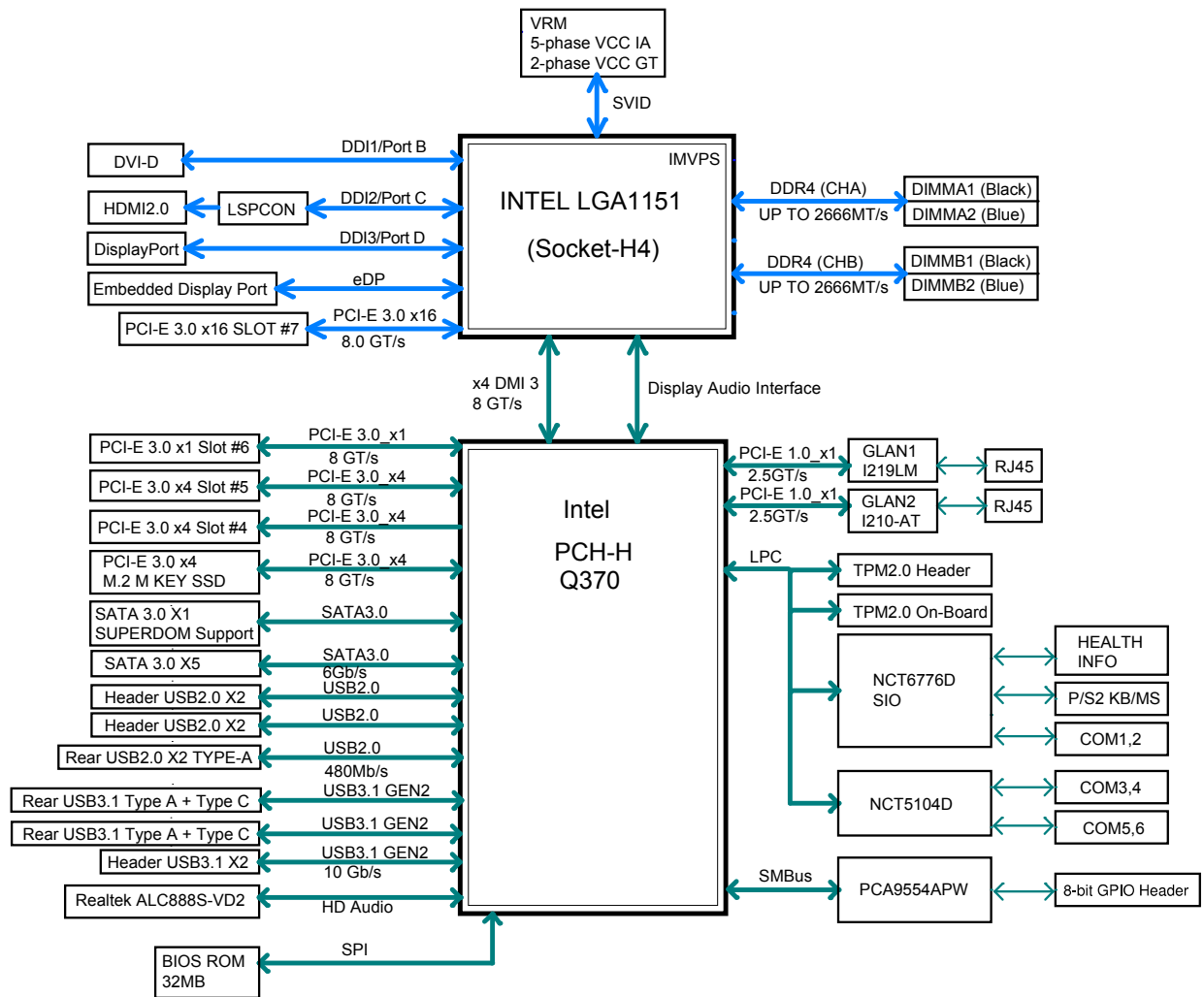

Note: This is a general block diagram and may not exactly represent the features on your motherboard. See the previous pages for the actual specifications of your motherboard.

Figure 1-5.
X11SCQ-L System Block Diagram

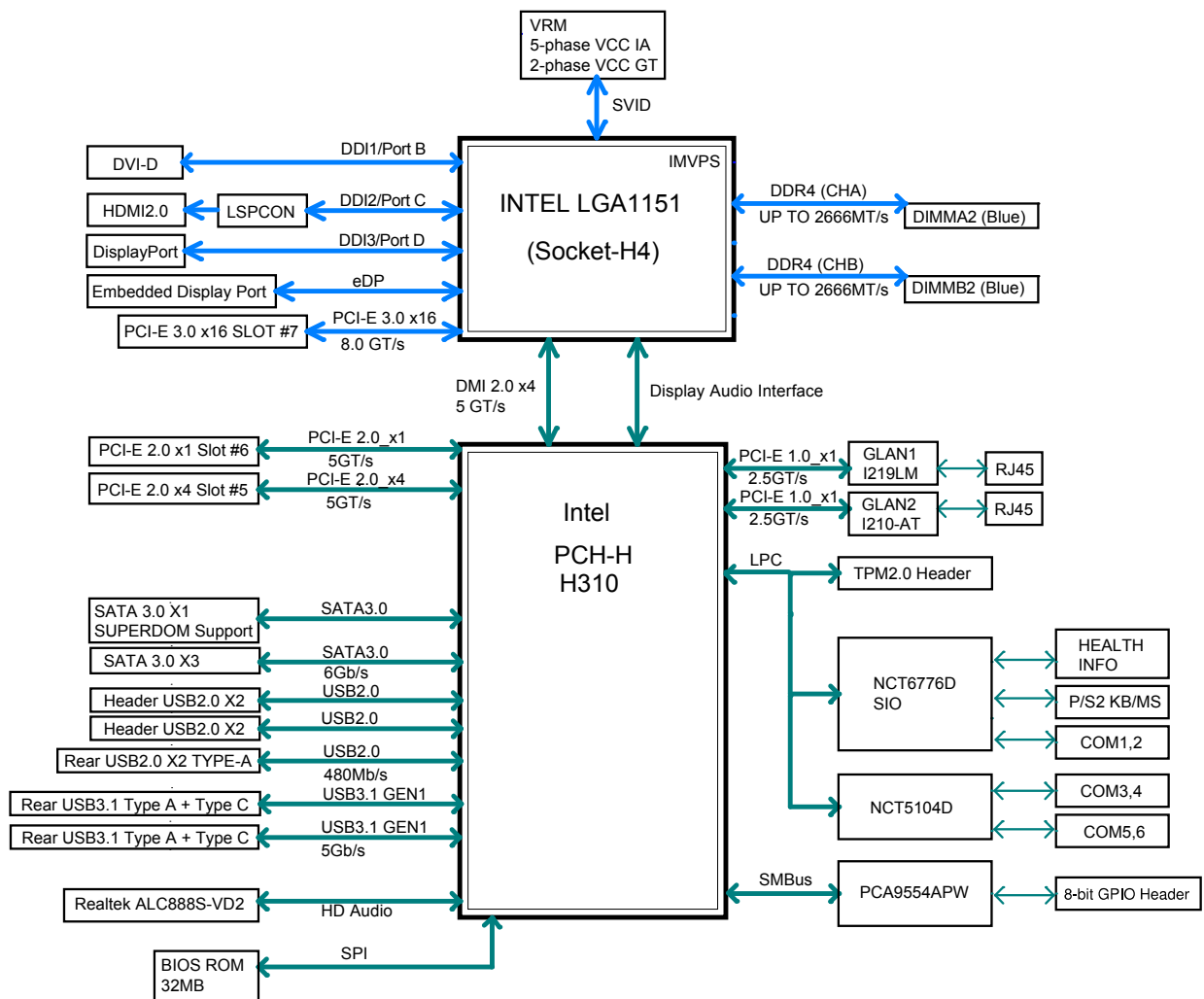

1.2 Processor and Chipset Overview

Built upon the functionality and capability of the Intel 8th Gen Core i3/i5/i7 and the Q370/H310 chipset, this motherboard provides superb system performance, efficient power management, and a rich feature set based on cutting edge technology to address the needs of next-generation computer users. This motherboard is optimized for medical and surveillance devices.

The Intel 8th Gen Core i3/i5/i7 processor and the Q370/H310 chipset support the following features:

- Intel® AMT 12.0, TXT, and AMT vPro (X11SCQ only)
- PCI-E 2.0/3.0, SATA 3.0, USB 3.1 Gen1/2
- Intel Hyper-Threading, Intel VT-D, VT-x
- TSX-NI, AES, SGX
- Intel Turbo Boost Technology
- Intel Rapid Storage Technology
- 32GB (X11SCQ-L) and 64GB (X11SCQ) DDR4 Memory Support up to 2666MHz
- Advanced Graphics Displays with Audio Stream, VP8, VP9, HEVC, OpenGL, Intel Quick Sync Video Technology

1.3 Special Features

This section describes the health monitoring features of the X11SCQ/-L motherboard. The motherboard has an onboard System Hardware Monitor chip that supports system health monitoring.

Recovery from AC Power Loss

The Basic I/O System (BIOS) provides a setting that determines how the system will respond when AC power is lost and then restored to the system. You can choose for the system to remain powered off (in which case you must press the power switch to turn it back on), or for it to automatically return to the power-on state. See the Advanced BIOS Setup section for this setting. The default setting is Last State.



Note: The motherboard offers a Force-On mode setting via jumper JAT1, putting it into AT mode for special applications that require the system to always power on when AC plugged in or when recovering from a power loss. Please refer to section 2.8 Jumper Settings.

1.4 System Health Monitoring

Onboard Voltage Monitors

The onboard voltage monitor will continuously scan crucial voltage levels. Once a voltage becomes unstable, it will give a warning or send an error message to the screen. The user can adjust the voltage thresholds to define the sensitivity of the voltage monitor. Real time readings of these voltage levels are all displayed in BIOS.

Fan Status Monitor with Firmware Control

The system health monitor chip can check the RPM status of a cooling fan. The CPU and chassis fans are controlled by the BIOS Thermal Management.

Environmental Temperature Control

The thermal control sensor monitors the CPU temperature in real time and will turn on the thermal control fan whenever the CPU temperature exceeds a user-defined threshold. The overheat circuitry runs independently from the CPU. Once the thermal sensor detects that the CPU temperature is too high, it will automatically turn on the thermal fans to prevent the CPU from overheating. The onboard chassis thermal circuitry can monitor the overall system temperature and alert the user when the chassis temperature is too high.



Note: To avoid possible system overheating, please provide adequate airflow to your system.

System Resource Alert

This feature is available when used with SuperDoctor 5® in the Windows® operating system or in the Linux environment. SuperDoctor 5 is used to notify the user of certain system events. For example, you can configure SuperDoctor 5 to provide you with warnings when the system temperature, CPU temperatures, voltages and fan speeds go beyond a predefined range.

1.5 ACPI Features

ACPI stands for Advanced Configuration and Power Interface. The ACPI specification defines a flexible and abstract hardware interface that provides a standard way to integrate power management features throughout a computer system including its hardware, operating system and application software. This enables the system to automatically turn on and off peripherals such as network cards, hard disk drives and printers.

In addition to enabling operating system-directed power management, ACPI also provides a generic system event mechanism for Plug and Play and an operating system-independent interface for configuration control. ACPI leverages the Plug and Play BIOS data structures while providing a processor architecture-independent implementation that is compatible with Windows® 10 operating system.

1.6 Power Supply

As with all computer products, a stable power source is necessary for proper and reliable operation. It is even more important for processors that have high CPU clock rates. The X11SCQ/-L motherboard accommodates 24-pin ATX power supplies. In addition, the 12V 8-pin power connector located at JPW2 is always required to ensure adequate power supply to the CPU.

Warning: To avoid damaging the power supply or motherboard, use a power supply that contains a 24-pin and a 8-pin power connectors. Be sure to connect the power supplies to the 24-pin (JPW1) and the 8-pin (JPW2) power connectors on the motherboard. Failure in doing so will void the manufacturer warranty on your power supply and motherboard.

It is strongly recommended that you use a high quality power supply that meets ATX power supply Specification 2.02 or above. It must also be SSI compliant (For more information, please refer to the web site at <http://www.ssiforum.org/>). Additionally, in areas where noisy power transmission is present, you may choose to install a line filter to shield the computer from noise. It is recommended that you also install a power surge protector to help avoid problems caused by power surges.

1.7 Super I/O

The Super I/O (NCT6776D) provides high-speed, 16550 compatible serial communication ports (UART), which support serial infrared communication. The UART includes send/receive FIFO, a programmable baud rate generator, complete modem control capability, and a processor interrupt system. The UART provides legacy speed with baud rate of up to 115.2 Kbps.

The Super I/O provides functions that comply with ACPI (Advanced Configuration and Power Interface), which includes support of legacy and ACPI power management through a SMI or SCI function pin. It also features auto power management to reduce power consumption.

Chapter 2

Installation

2.1 Static-Sensitive Devices

Electrostatic Discharge (ESD) can damage electronic components. To avoid damaging your motherboard and your system, it is important to handle it very carefully. The following measures are generally sufficient to protect your equipment from ESD.

Precautions

- Use a grounded wrist strap designed to prevent static discharge.
- Touch a grounded metal object before removing the board from the antistatic bag.
- Handle the board by its edges only; do not touch its components, peripheral chips, memory modules or gold contacts.
- When handling chips or modules, avoid touching their pins.
- Put the motherboard and peripherals back into their antistatic bags when not in use.
- For grounding purposes, make sure that your chassis provides excellent conductivity between the power supply, the case, the mounting fasteners and the motherboard.
- Use only the correct type of CMOS onboard battery as specified by the manufacturer. Do not install the CMOS battery upside down, which may result in a possible explosion.

Unpacking

The motherboard is shipped in antistatic packaging to avoid static damage. When unpacking the motherboard, make sure that the person handling it is static protected.

2.2 Motherboard Installation

All motherboards have standard mounting holes to fit different types of chassis. Make sure that the locations of all the mounting holes for both the motherboard and the chassis match. Although a chassis may have both plastic and metal mounting fasteners, metal ones are highly recommended because they ground the motherboard to the chassis. Make sure that the metal standoffs click in or are screwed in tightly.



Phillips Screwdriver (1)



Phillips Screws (8)



Standoffs (8)
Only if Needed

Tools Needed

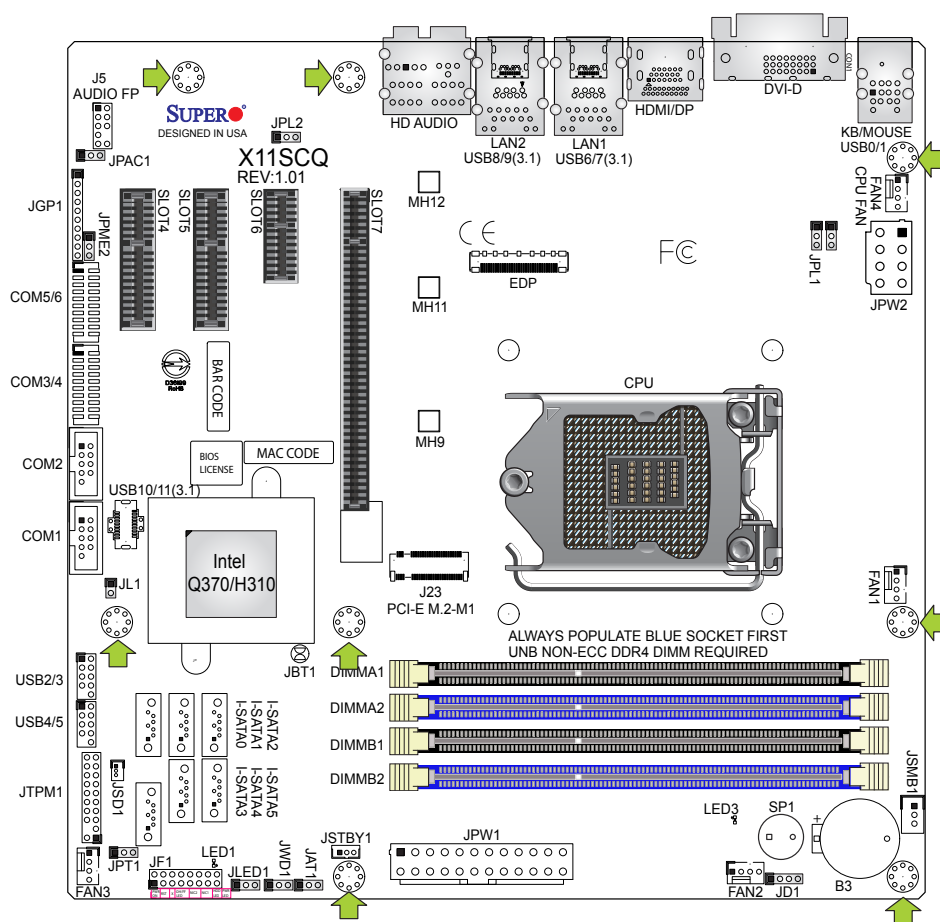

Installing the Motherboard

1. Install the I/O shield into the back of the chassis.

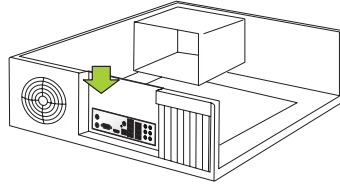

2. Locate the mounting holes on the motherboard. See the previous page for the location.

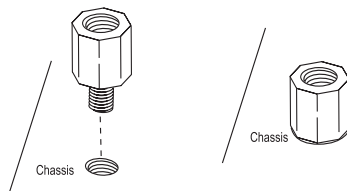

3. Locate the matching mounting holes on the chassis. Align the mounting holes on the motherboard against the mounting holes on the chassis.

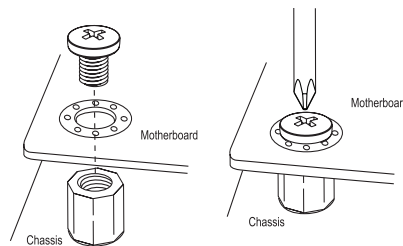

4. Install standoffs in the chassis as needed.
5. Install the motherboard into the chassis carefully to avoid damaging other motherboard components.
6. Using the Phillips screwdriver, insert a Phillips head #6 screw into a mounting hole on the motherboard and its matching mounting hole on the chassis.
7. Repeat Step 5 to insert #6 screws into all mounting holes.
8. Make sure that the motherboard is securely placed in the chassis.

 **Note:** Images displayed are for illustration only. Your chassis or components might look different from those shown in this manual.

2.3 Processor and Heatsink Installation

Warning: When handling the processor package, avoid placing direct pressure on the label area of the fan.



Important:

- Always connect the power cord last, and always remove it before adding, removing or changing any hardware components. Make sure that you install the processor into the CPU socket before you install the CPU heatsink.
- If you buy a CPU separately, make sure that you use an Intel-certified multi-directional heatsink only.
- Make sure to install the motherboard into the chassis before you install the CPU heatsink.
- When receiving a motherboard without a processor pre-installed, make sure that the plastic CPU socket cap is in place and none of the socket pins are bent; otherwise, contact your retailer immediately.
- Refer to the Supermicro website for updates on CPU support.

Installing the LGA1151 Processor

1. Press the load lever down to release the load plate from its locking position.

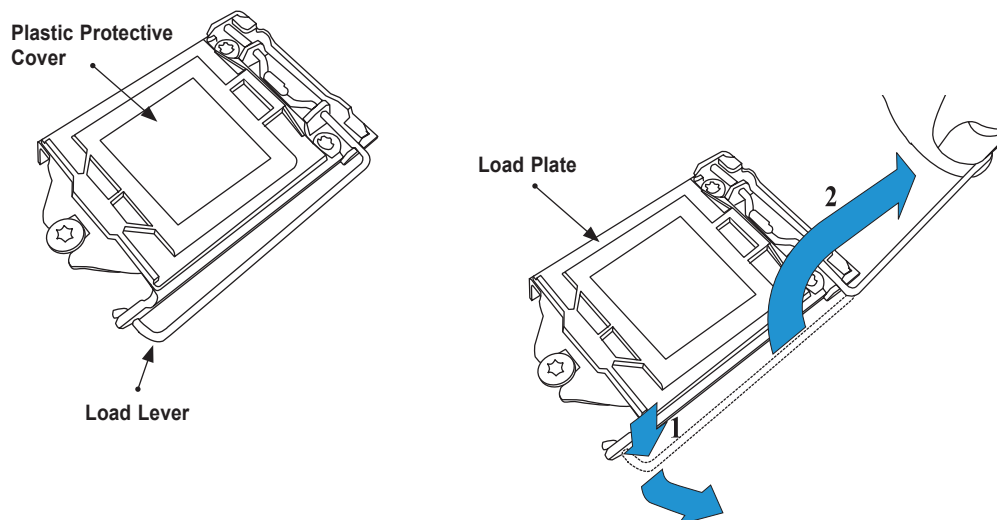

2. Gently lift the load lever to open the load plate. Remove the plastic protective cover. Do not touch the CPU socket contacts.

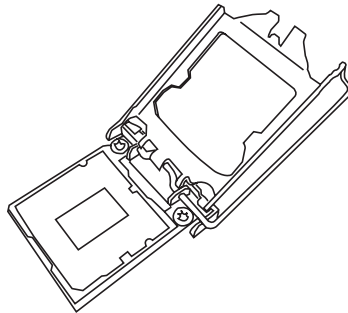

3. Locate the triangle on the CPU and CPU socket, which indicates the location of Pin 1. Holding the CPU by the edges with your thumb and index finger, align the triangle on the CPU with the triangle on the socket. The CPU keys (the semi-circle cutouts) may also be aligned against the socket keys as a guide.

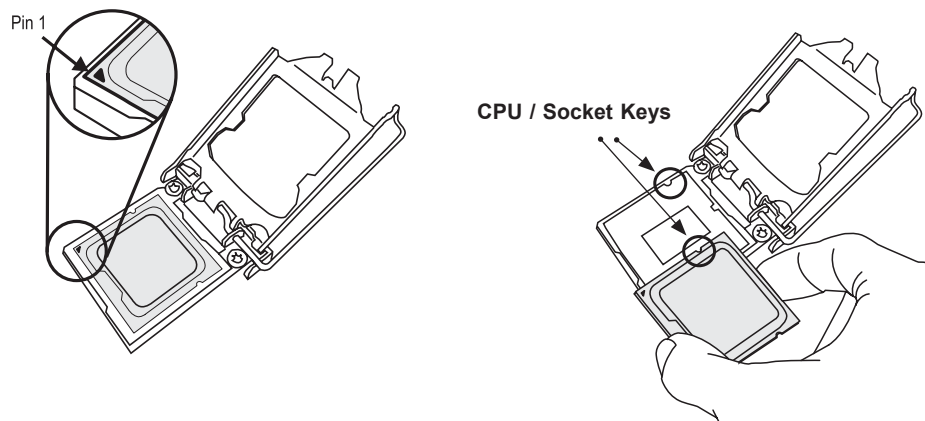

4. Carefully lower the CPU straight down into the socket. Do not drop the CPU on the socket, or move it horizontally or vertically to avoid damaging the CPU or socket. Inspect the four corners of the CPU to make sure that the CPU is properly installed.

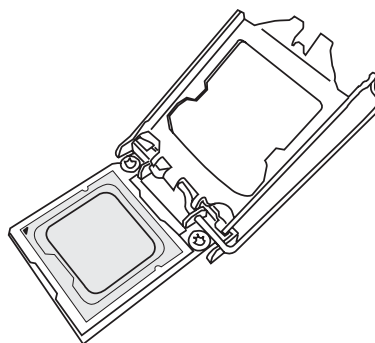

5. Close the load plate, then gently push down the load lever into its locking position.

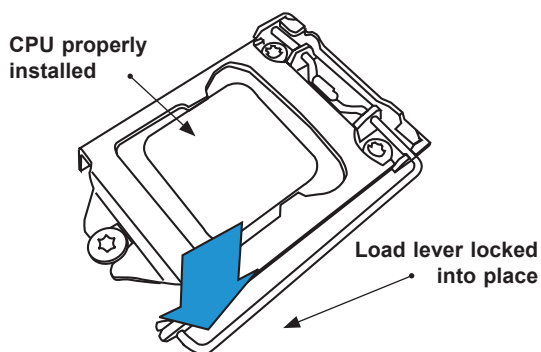

 **Note:** You can only install the CPU in one direction. Make sure it is properly inserted into the socket before closing the load plate. If it doesn't close properly, do not force it as it may damage your CPU. Instead, open the load plate again and double-check that the CPU is properly aligned.

Installing an Active CPU Heatsink with Fan

1. Locate the CPU fan header on the motherboard (FAN1: CPU FAN).
2. Position the heatsink so that the heatsink fan wires are closest to the CPU fan header and are not interfering with other components.
3. Inspect the CPU fan wires to make sure they are routed through the bottom of the heatsink.
4. Remove the thin layer of protective film from the heatsink. CPU overheating may occur if the protective film is not removed from the heatsink.
5. Apply the proper amount of thermal grease on the CPU. If your heatsink came with a thermal pad, please ignore this step.

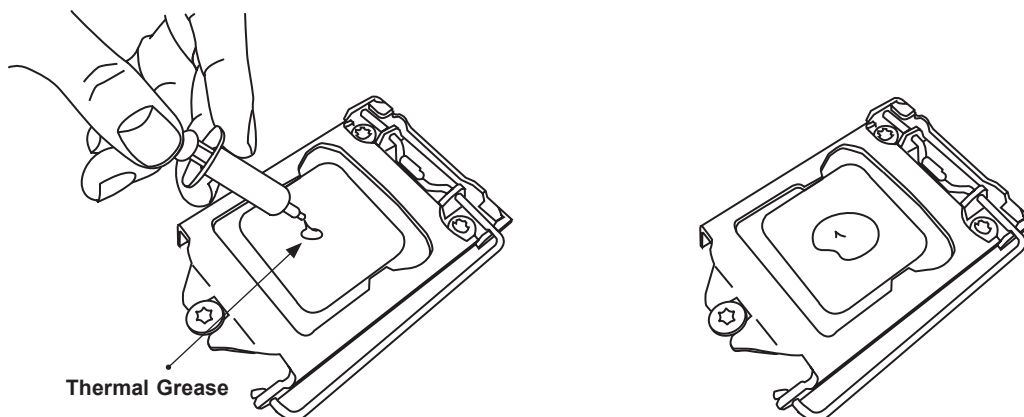

6. Align the four heatsink fasteners with the mounting holes on the motherboard. Gently push down the fasteners in a diagonal order (Example: #1 and #2, then #3 and #4) into the mounting holes until you hear a click. Then lock the fasteners by turning each one 90° clockwise.

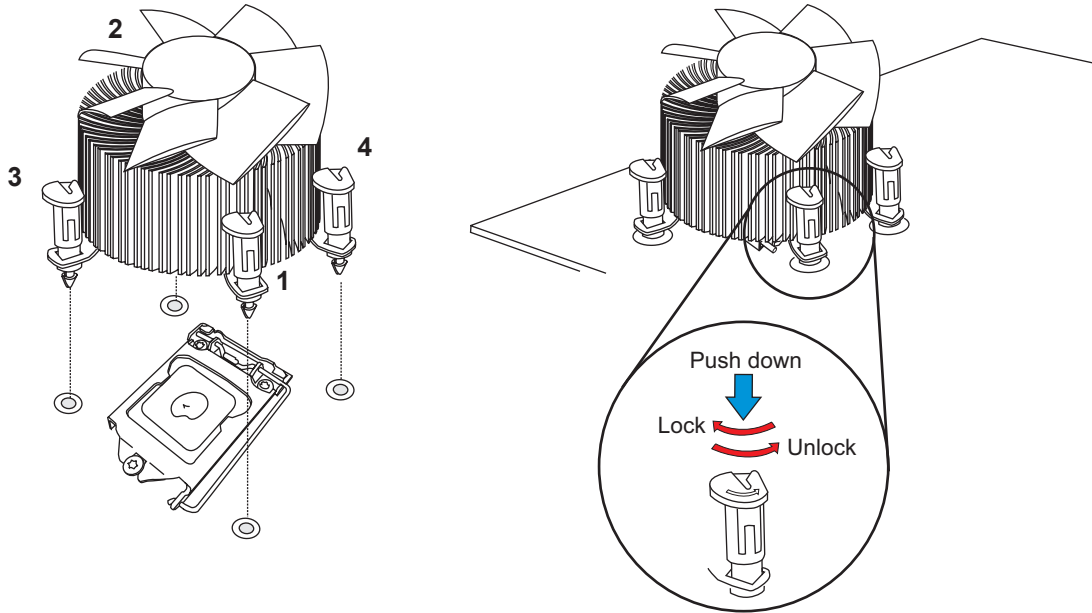

7. Once all four fasteners are secured, connect the heatsink fan wire connector to the CPU fan header.

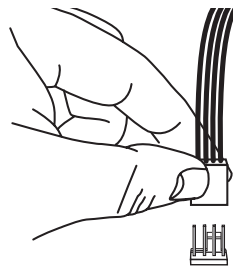

Removing the Heatsink

 **Note:** We do not recommend that the CPU or heatsink be removed. However, if you do need to remove the heatsink, please follow the instructions below to remove the heatsink and prevent damage done to the CPU or other components.

1. Unplug the power connector from the power supply.
2. Disconnect the heatsink fan connector from the CPU fan header.
3. Gently press down each fastener cap and turn them 90° counter clockwise, then pull the fasteners upwards to loosen them.
4. Remove the heatsink from the CPU.

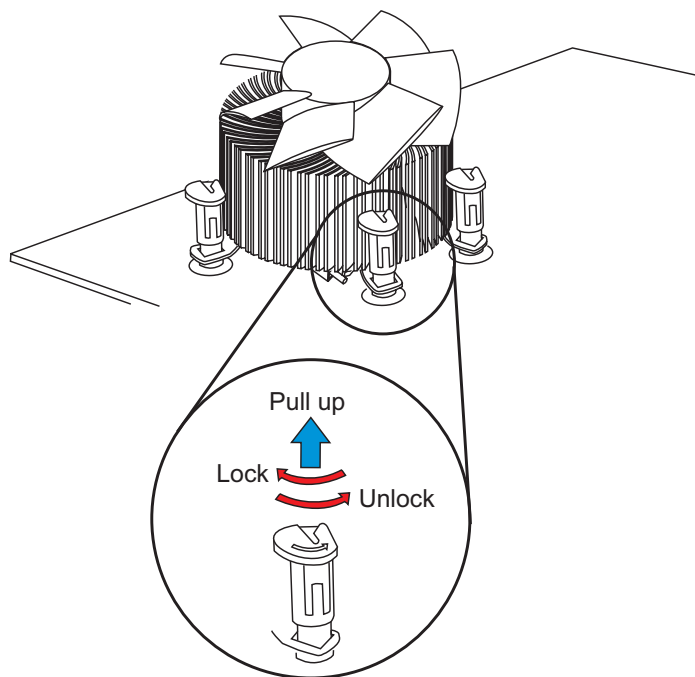

2.4 Memory Support and Installation

Memory Support

The X11SCQ motherboard supports up to 64GB of Non-ECC UDIMM with speeds of up to 2666MHz in four slots. The X11SCQ-L supports up to 32GB of Non-ECC UDIMM with speeds of up to 2666MHz in two slots. Populating the DIMM slots with a pair of memory modules of the same type, speed and size will result in interleaved memory, which improves performance.

DIMM Module Population Configuration

For optimal memory performance, follow the table below when populating memory.

Recommended Population (Balanced)				
DIMMA1 (X11SCQ only)	DIMMB1 (X11SCQ only)	DIMMA2	DIMMB2	Total System Memory
		4GB	4GB	8GB
4GB	4GB	4GB	4GB	16GB
		8GB	8GB	16GB
8GB	8GB	8GB	8GB	32GB
		16GB	16GB	32GB
16GB	16GB	16GB	16GB	64GB

DIMM Module Population Sequence

When installing memory modules, the DIMM slots must be populated in the following order: DIMMB2, DIMMA2, then DIMMB1, DIMMA1. The blue slots must be populated first.

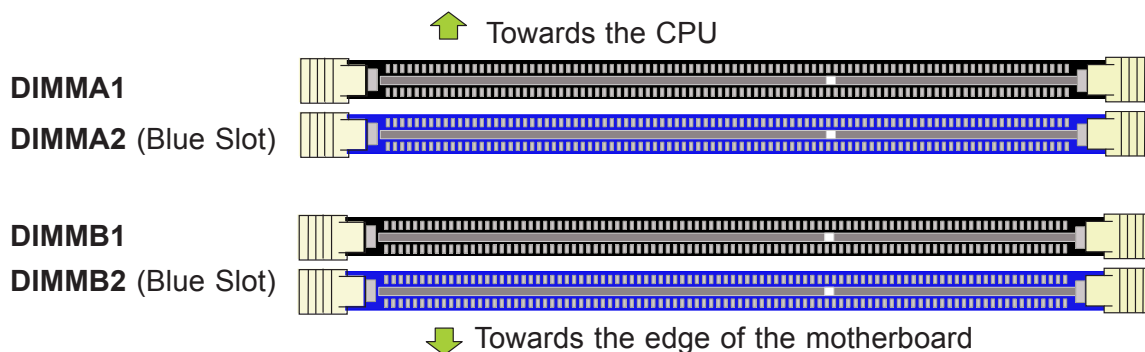

DIMM Installation

1. Insert DIMM modules in the following order: DIMMA2, DIMMB2, then DIMMA1, DIMMB1. For the system to work properly, use memory modules of the same type and speed.
2. Align the DIMM module key with the receptive point on the single-latch DIMM slot.
3. Push the release tab outwards to unlock the slot.
4. Align the notch on the end of the module against the receptive point on the end of the slot.
5. Press both ends of the module straight down into the slot until the module snaps into place.
6. Push the release tab to the lock position to secure the module into the slot.

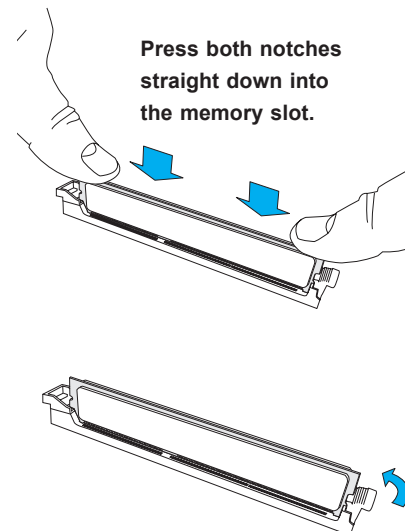
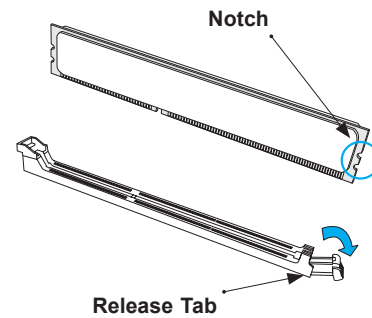
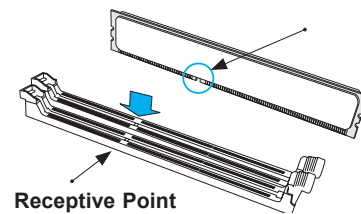
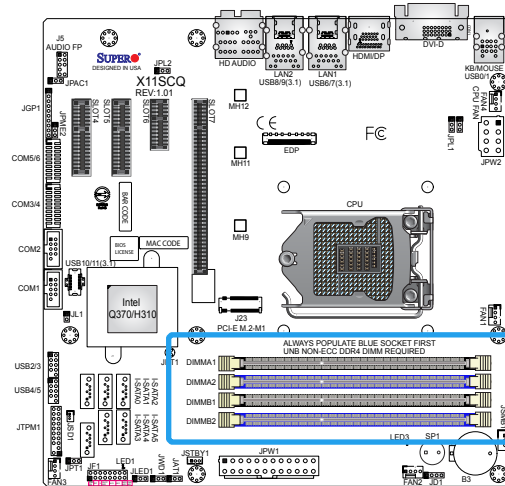

DIMM Removal

Reverse the steps above to remove the DIMM modules from the motherboard.

2.5 Rear I/O Ports

See the figure below for the locations and descriptions of the various I/O ports on the rear of the motherboard.

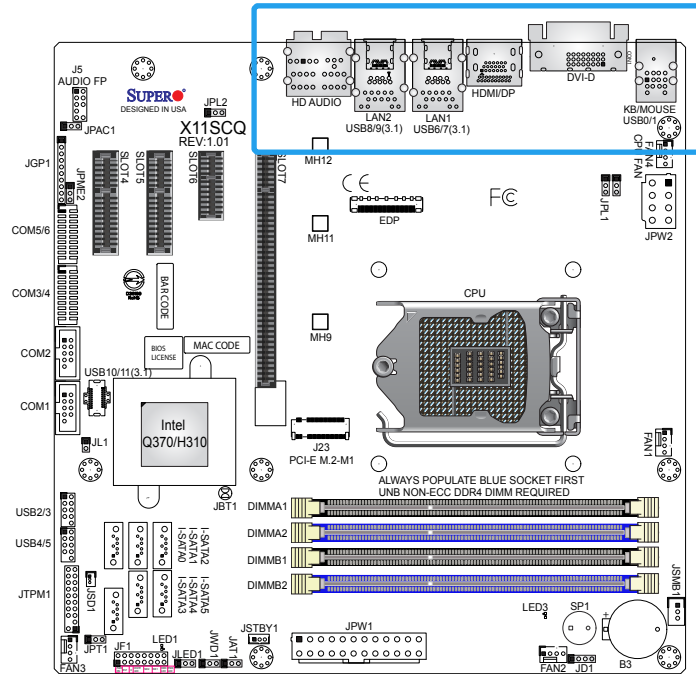
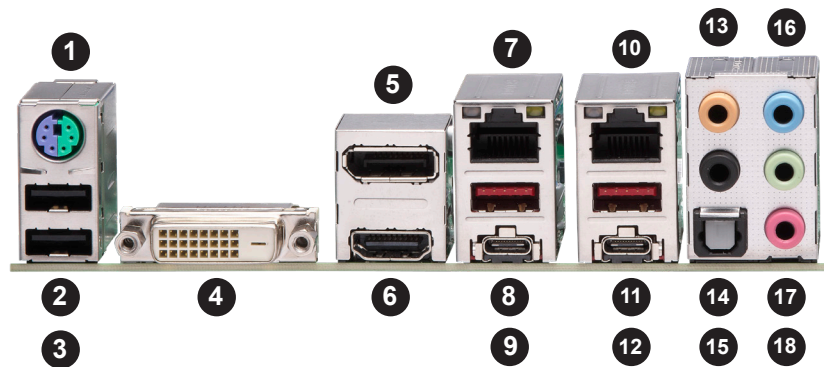

Figure 2-2. I/O Port Location and Definitions



#	Description	#	Description	#	Description	#	Description
1.	KB/Mouse	6.	HDMI	11.	USB9* (3.1)	16.	Line In
2.	USB1 (2.0)	7.	LAN1	12.	USB8* (3.1)	17.	Line Out
3.	USB0 (2.0)	8.	USB7* (3.1)	13.	CEN/LFE Out	18.	Mic In
4.	DVI-D	9.	USB6* (3.1)	14.	Surround Out		
5.	DP	10.	LAN2	15.	SPDIF Out		

* USB 3.1 Gen 2 on X11SCQ

* USB 3.1 Gen 1 on X11SCQ-L

* USB 3.1 Gen 1 is also referred to as USB3.0

DP Port

DisplayPort, developed by the VESA consortium, delivers digital display and fast refresh rate. It can connect to virtually any display device using a DisplayPort adapter for devices such as VGA, DVI or HDMI.

HDMI Port

One HDMI (High Definition Multimedia Interface) port is on the I/O back panel. This connector is used to display both high definition video and digital sound through an HDMI-capable display, using a single HDMI cable (not included).

DVI-D Port

A DVI-D port is on the I/O back panel. Use this port to connect to a compatible DVI (Digital Visual Interface) display.

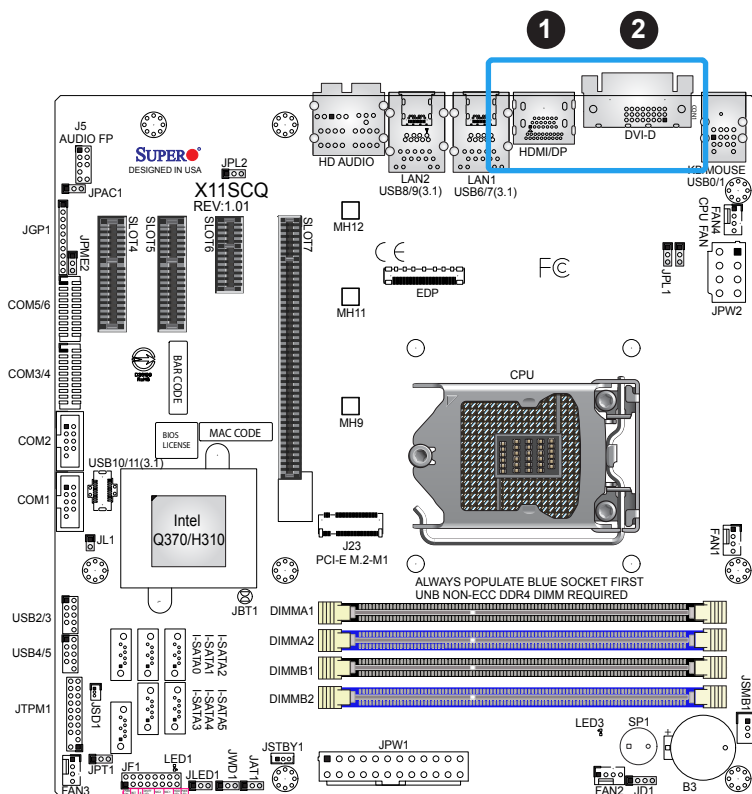

1. HDMI/DP Ports
2. DVI-D Port

Embedded DisplayPort

The eDP header is used to connect an embedded display LED or LCD Panel. eDP is a companion standard to the DisplayPort interface designed for embedded display applications, including notebook PCs, tablets, netbooks and all-in-one desktop PCs. The X11SCQ/L supports 3.3V eDP LED or LCD panel only. The X11SCQ/L supports eDP standard version 1.4. Refer to the table below for pin definitions.

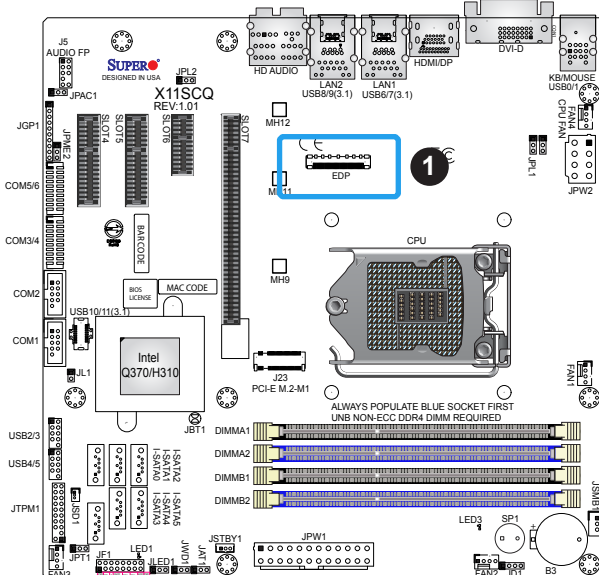
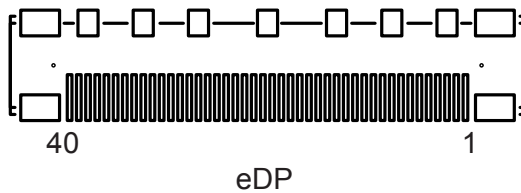

eDP Header Connector: DF80-40S-0.5V(51) Pin Definitions			
Pin#	Definition	Pin#	Definition
1	P3V3_EDP	21	eDP_TXN0
2	P3V3_EDP	22	eDP_TXP0
3	P3V3_EDP	23	GND
4	P3V3_EDP	24	eDP_AUXP
5	P3V3_EDP	25	eDP_AUXN
6	GND	26	NC
7	GND	27	P3V3
8	GND	28	NC
9	GND	29	P12V
10	EDP_HPD	30	NC
11	GND	31	GND
12	eDP_TXN3	32	P5V
13	eDP_TXP3	33	EDP_3P3_ BKLCTCL
14	GND	34	EDP_3P3_ BKLEN
15	eDP_TXN2	35	P12V
16	eDP_TXP2	36	P3V3
17	GND	37	GND
18	eDP_TXN1	38	NC
19	eDP_TXP1	39	NC
20	GND	40	NC

1. eDP

LAN Ports

There are two 1GbE LAN ports (LAN1/LAN2) on the I/O back panel. These ports accept RJ45 type cables. Refer to the table below for the pin definitions.

LAN Port Pin Definition			
Pin#	Definition	Pin#	Definition
1	TX_D1+	5	BI_D3-
2	TX_D1-	6	RX_D2-
3	RX_D2+	7	BI_D4+
4	BI_D3+	8	BI_D4-

KB/Mouse

Use the KB port to connect a PS2 Keyboard and the Mouse port to connect a PS2 mouse.

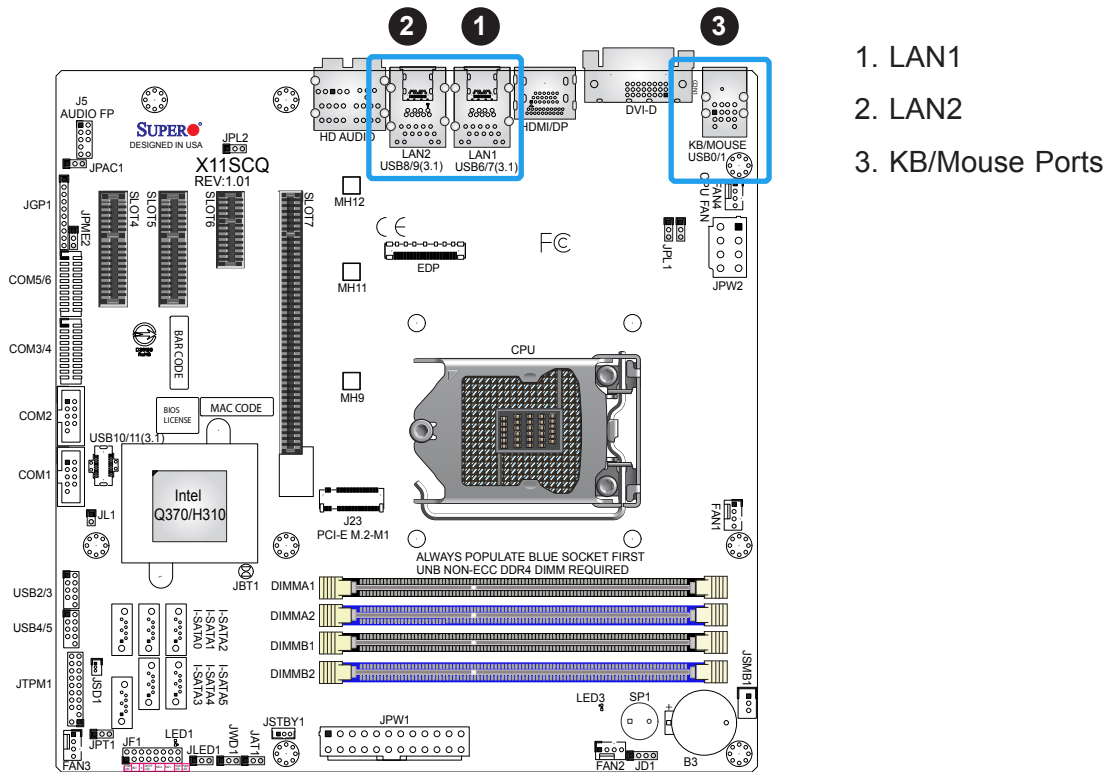

Universal Serial Bus (USB) Header

There are two USB 2.0 headers (USB2/3, USB4/5), one USB 3.1 Gen 2 header (USB10/11 - X11SCQ only) on the motherboard to provide front access connection with a cable (not included). There are also two USB 2.0 ports (USB0/1) and four USB 3.1 ports (USB6/7, USB8/9 - Gen 2 on X11SCQ/Gen 1 on X11SCQ-L) on the I/O back panel. USB7 and USB9 are Type-A; USB6 and USB8 are Type-C on the I/O back panel.

Front Panel USB 3.1 Gen 2 Header (USB10/11 - X11SCQ only) Pin Definitions			
Pin#	Definition	Pin#	Definition
1	GND	11	GND
2	TX1+	12	TX2-
3	TX1-	13	TX2+
4	GND	14	GND
5	RX1+	15	RX2-
6	RX1-	16	RX2+
7	GND	17	GND
8	D1+	18	D2+
9	D1-	19	D2-
10	VBUS	20	VBUS

Front Panel USB 2.0 Header (USB2/3, USB4/5) Pin Definitions			
Pin#	Definition	Pin#	Definition
1	+5V	2	+5V
3	USB_PN2	4	USB_PN3
5	USB_PP2	6	USB_PP3
7	Ground	8	Ground
9	Key	10	Ground

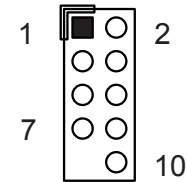

USB2.0 Header

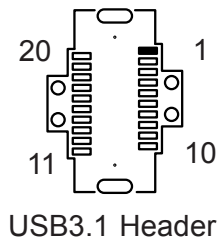

USB3.1 Header

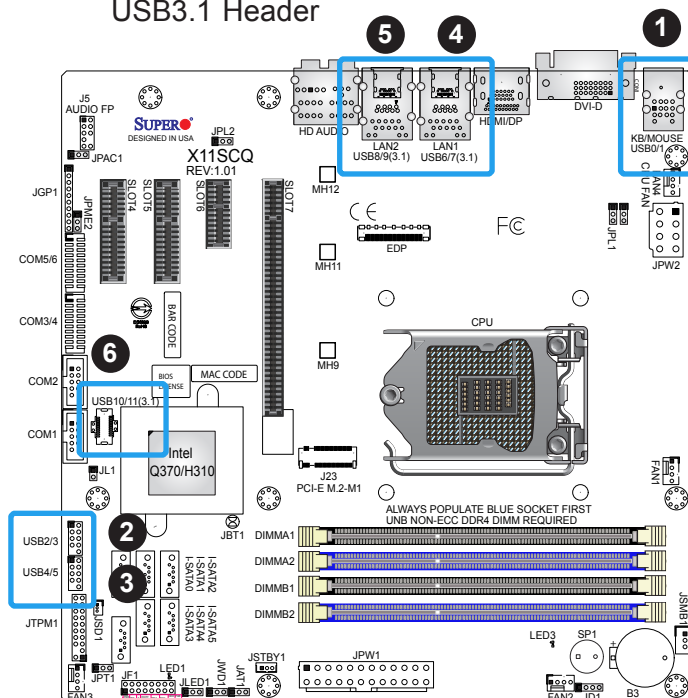

1. USB0/1
2. USB2/3
3. USB4/5
4. USB6/7
5. USB8/9
6. USB10/11 (X11SCQ only)

2.6 Front Control Panel

JF1 contains header pins for various buttons and indicators that are normally located on a control panel at the front of the chassis. These connectors are designed specifically for use with Supermicro chassis. See the figure below for the descriptions of the front control panel buttons and LED indicators.

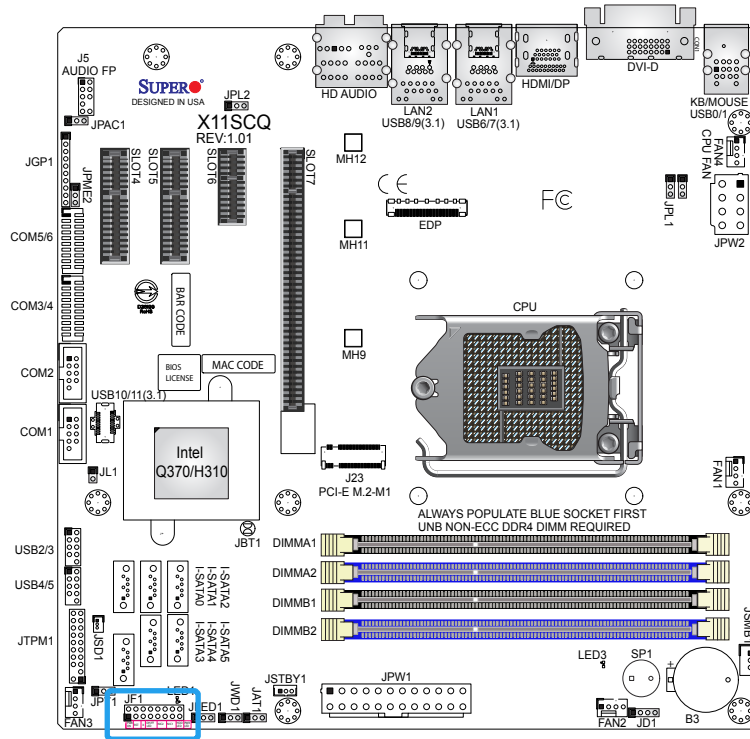

Figure 2-3. JF1 Header Definitions

	1	2	
PWR } Power Button	○	○	Ground
Reset } Reset Button	○	○	Ground
X	○	○	X
+3.3V	○	○	OH/Fan Fail LED
3.3V Stby	○	○	NIC2 Activity LED
3.3V Stby	○	○	NIC1 Activity LED
+3.3V	○	○	HDD LED
+3.3V Stby	○	○	PWR LED
	15	16	

Power Button

The Power Button connection is located on pins 1 and 2 of JF1. Momentarily contacting both pins will power on/off the system. This button can also be configured to function as a suspend button (with a setting in the BIOS - see Chapter 4). To turn off the power in the suspend mode, press the button for at least 4 seconds. Refer to the table below for pin definitions.

Power Button Pin Definitions (JF1)	
Pins	Definition
1	Signal
2	Ground

Reset Button

The Reset Button connection is located on pins 3 and 4 of JF1. Attach it to a hardware reset switch on the computer case to reset the system. Refer to the table below for pin definitions.

Reset Button Pin Definitions (JF1)	
Pins	Definition
3	Reset
4	Ground

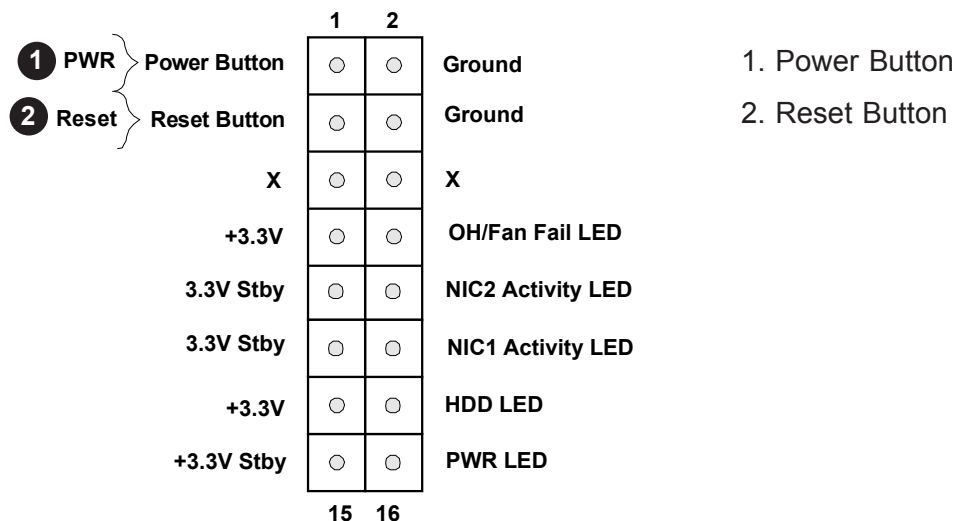

Overheat (OH)/Fan Fail

Connect an LED cable to OH/Fan Fail connections on pins 7 and 8 of JF1 to provide warnings for chassis overheat/fan failure. Refer to the table below for pin definitions.

OH/Fan Fail Indicator Pin Definitions	
Pin#	Definition
Off	Normal
On	Overheat
Flashing	Fan Fail

OH/Fan Fail LED Pin Definitions (JF1)	
Pins	Definition
7	+3.3V
8	OH/Fan Fail LED

NIC1/NIC2 (LAN1/LAN2)

The NIC (Network Interface Controller) LED connection for LAN port 1 is located on pins 11 and 12 of JF1, and the LED connection for LAN Port 2 is on pins 9 and 10. Attach NIC LED cables to NIC1 and NIC2 LED indicators to display network activities. Refer to the table below for pin definitions.

LAN1/LAN2 LED Pin Definitions (JF1)	
Pins	Definition
9/11	3.3V Stby
10/12	NIC Activity LED

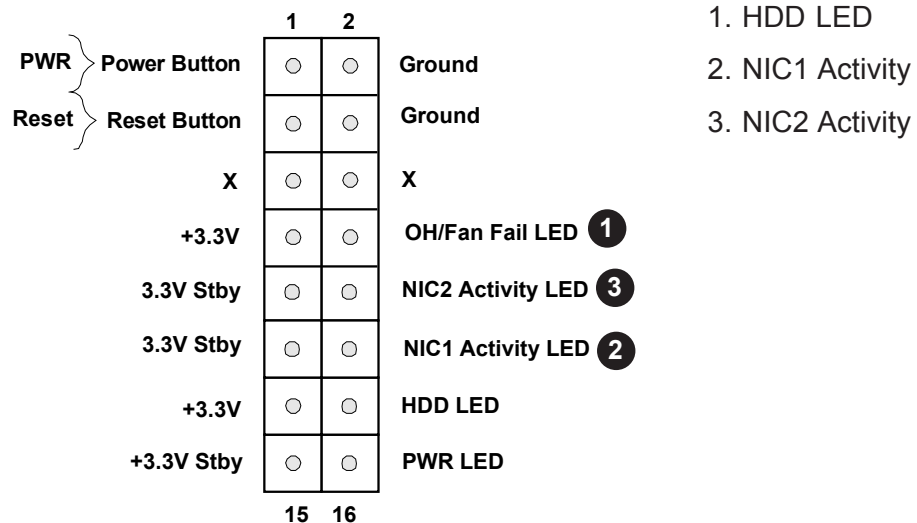

HDD LED

The HDD LED connection is located on pins 13 and 14 of JF1. Attach a cable here to show hard drive activity status. Refer to the table below for pin definitions.

HDD LED Pin Definitions (JF1)	
Pins	Definition
13	+3.3V
14	HDD LED

Power LED

The Power LED connection is located on pins 15 and 16 of JF1. Refer to the table below for pin definitions.

Power LED Pin Definitions (JF1)	
Pins	Definition
15	+3.3V Stby
16	PWR LED

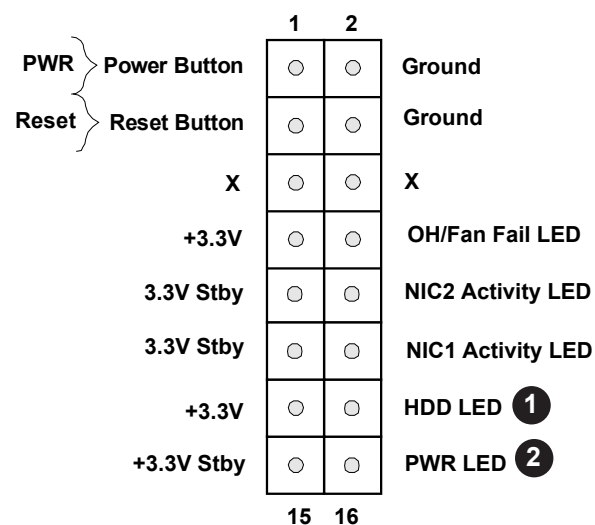

1. HDD LED
2. Power LED

2.7 Connectors

Main ATX Power Supply Connector

The primary power supply connector (JPW1) meets the ATX SSI EPS 24-pin specification. You must also connect the 8-pin (JPW2) 12V CPU power connector to your power supply.

ATX Power 24-pin Connector Pin Definitions			
Pin#	Definition	Pin#	Definition
13	+3.3V	1	+3.3V
14	-12V	2	+3.3V
15	COM	3	COM
16	PS_ON	4	+5V
17	COM	5	COM
18	COM	6	+5V
19	COM	7	COM
20	Res (NC)	8	PWR_OK
21	+5V	9	5VSB
22	+5V	10	+12V
23	+5V	11	+12V
24	COM	12	+3.3V

Required Connection

8-pin CPU Power Pin Definitions	
Pin#	Definition
1-4	GND
5-8	12V

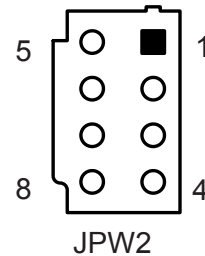

1. 24-pin ATX Power
2. 8-pin CPU Power

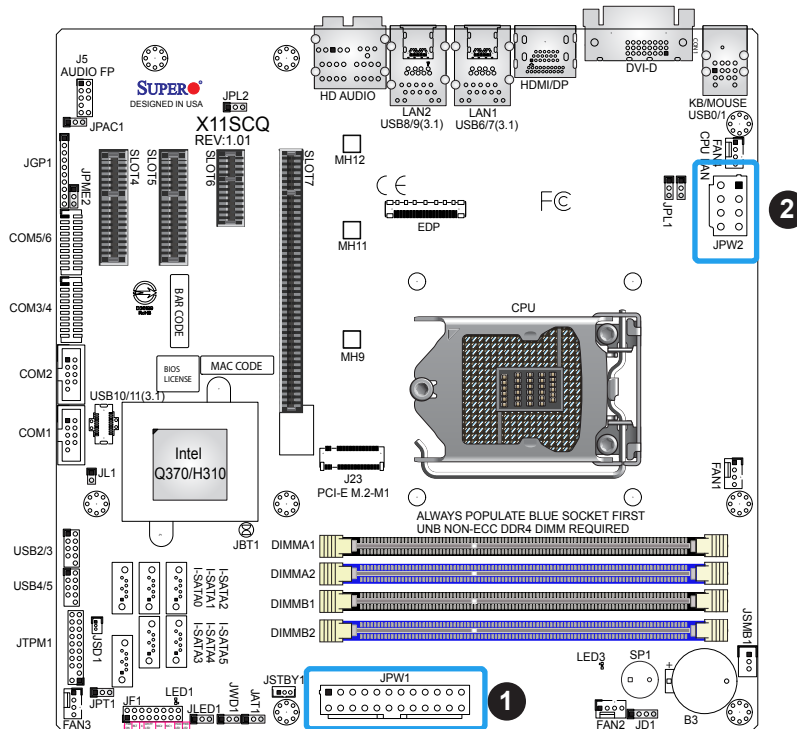

TPM Header

The JTPM1 header is used to connect a Trusted Platform Module (TPM)/Port 80. A TPM/Port 80 connector is a security device that supports encryption and authentication in hard drives. It allows the motherboard to deny access if the TPM associated with the hard drive is not installed in the system. See the layout below for the location of the TPM header.

Trusted Platform Module/Port80 Header Pin Definitions			
Pin#	Definition	Pin#	Definition
1	LCLK	2	GND
3	LFRAME#	4	<(KEY)>
5	LRESET#	6	+5V (X)
7	LAD3	8	LAD2
9	+3.3V	10	LAD1
11	LAD0	12	GND
13	SMB_CLK4 (X)	14	SMB_DAT4 (X)
15	P3V3_STBY	16	SERIRQ
17	GND	18	CLKRUN#
19	LPCPD#	20	LDRQ# (X)

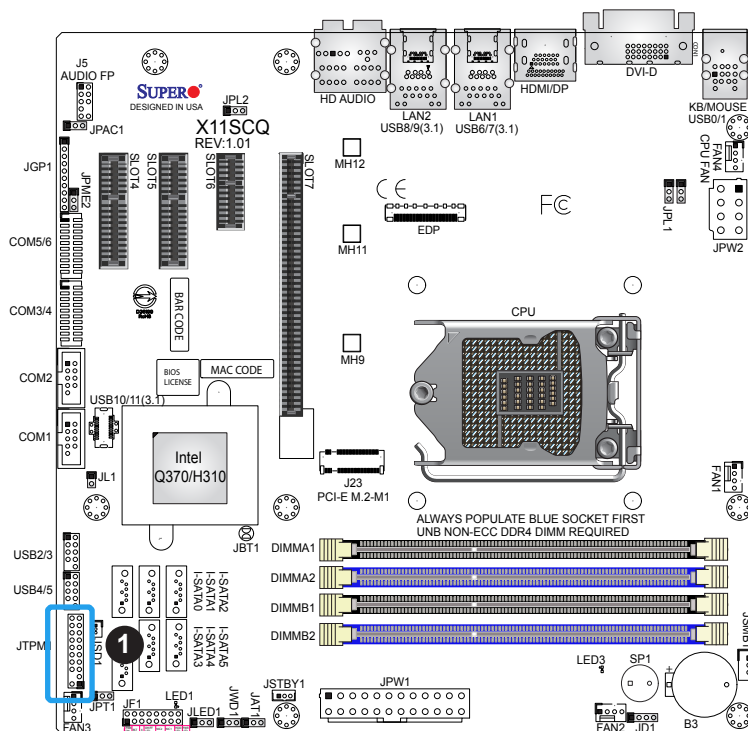

1. TPM/Port 80 Header

System Management Bus Header

A System Management Bus header for additional slave devices or sensors is located at JSMB1. See the table below for pin definitions.

SMBus Header Pin Definitions	
Pin#	Definition
1	Clock
2	Data
3	Ground

Disk On Module Power Connector

The Disk On Module (DOM) power connector at JSD1 provides 5V power to a solid-state DOM storage device connected to one of the SATA ports. Refer to the table below for pin definitions.

DOM Power Pin Definitions	
Pin#	Definition
1	5V
2	Ground
3	Ground

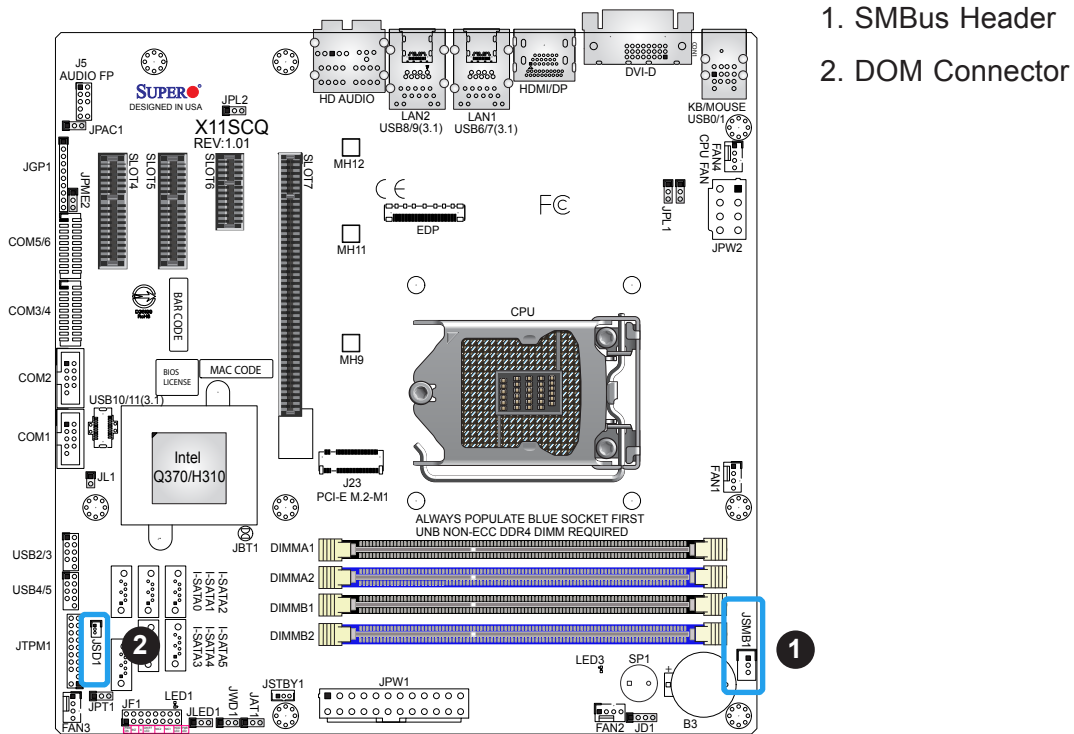

I-SATA 3.0 Ports

The X11SCQ has six I-SATA 3.0 ports (I-SATA0 - I-SATA5), whereas the X11SCQ-L has four SATA 3.0 ports (I-SATA0 - I-SATA3). I-SATA0 can be used with Supermicro SuperDOMs that are yellow SATA DOM connectors with power pins built in, and do not require external power cables. Supermicro SuperDOMs are backward compatible with regular SATA HDDs or SATA DOMs that need external power cables.

M.2 Slot (X11SCQ only)

There is one M.2 slot on the motherboard. M.2 is formerly known as Next Generation Form Factor (NGFF). The M.2 slot is designed for a M-key PCI-E 3.0 x4 storage device in 2242, 2282, and 22110 form factors.

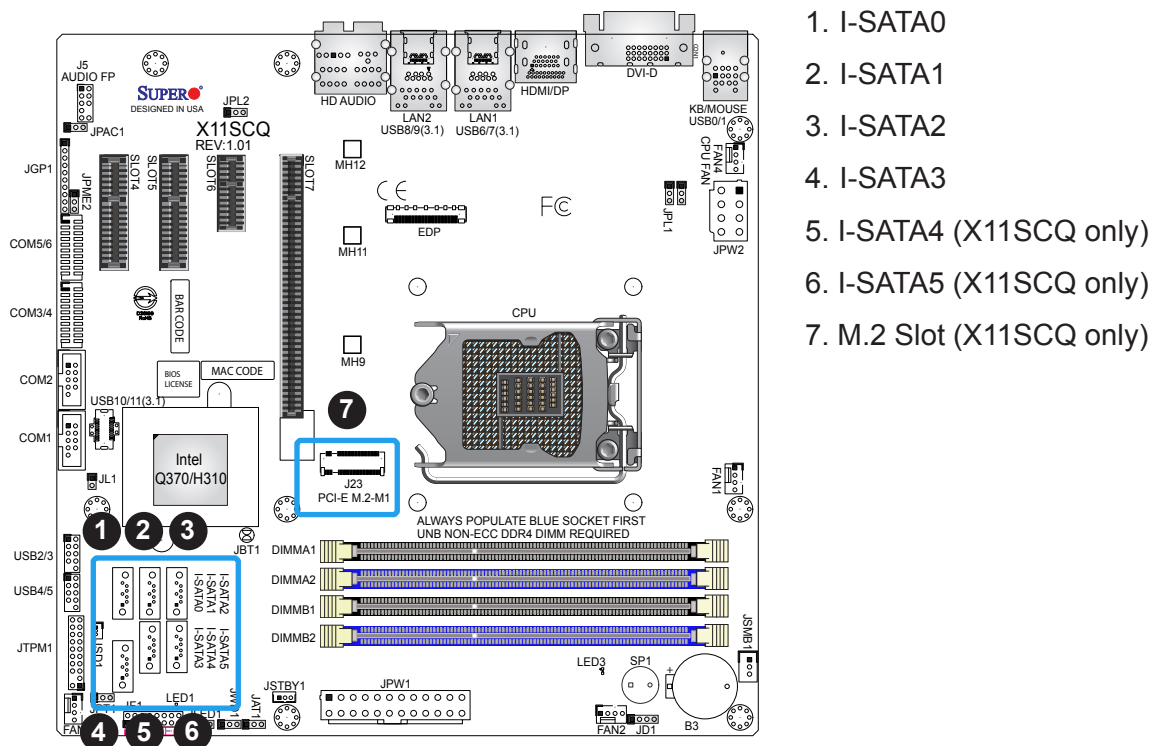

1. I-SATA0
2. I-SATA1
3. I-SATA2
4. I-SATA3
5. I-SATA4 (X11SCQ only)
6. I-SATA5 (X11SCQ only)
7. M.2 Slot (X11SCQ only)

Speaker/Buzzer

On the JD1 header, pins 1-4 are for the external speaker and pins 3-4 are for the buzzer.

Speaker Connector Pin Definitions	
Pin Setting	Definition
Pins 1-4	Speaker
Pins 3-4	Buzzer

Chassis Intrusion

A Chassis Intrusion header is located at JL1 on the motherboard. Attach the appropriate cable from the chassis to the header to inform you when the chassis is opened.

Chassis Intrusion Pin Definitions	
Pins	Definition
1	Intrusion Input
2	Ground

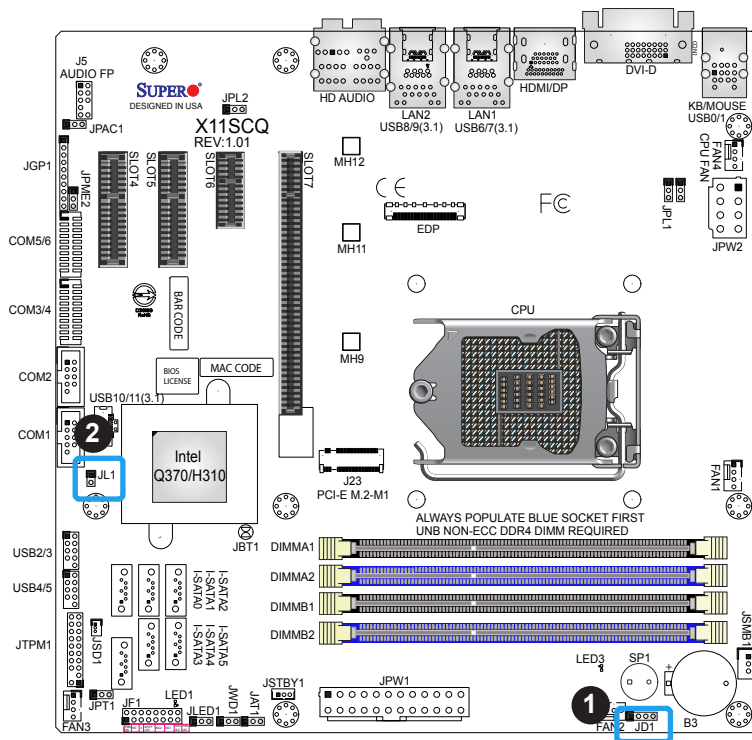

1. Speaker/Buzzer
2. Chassis Intrusion

Front Accessible Audio Header

A 10-pin audio header located AUDIO FP allows you to use the onboard sound for audio playback. Connect an audio cable to this header to use this feature. Refer to the table below for pin definitions.

Audio Header Pin Definitions			
Pin#	Definition	Pin#	Definition
1	Mic_2_Left	2	Audio_Ground
3	Mic_2_Right	4	Audio_Detect
5	Line_2_Right	6	Mic_2_JD
7	Jack_Detect	8	Key
9	Line_2_Left	10	Line_2_JD

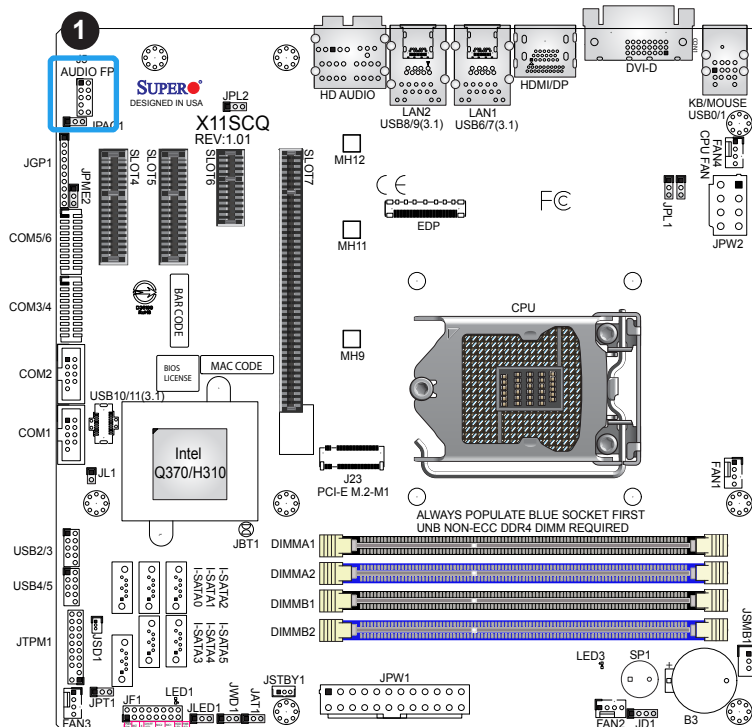

1. AUDIO FP

High Definition Audio

This motherboard features a 7.1+2 Channel High Definition Audio (HDA) codec that provides 10 DAC channels. The HD Audio connections simultaneously support multiple-streaming 7.1 sound playback with two channels of independent stereo output through the front panel stereo out for front, rear, center and subwoofer speakers. Download the software from our website to enable this feature.

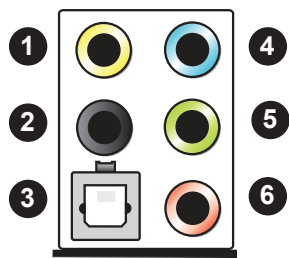

5.1 HD Audio Pin Definitions	
Con#	Definition
1	CEN/LFE Out
2	Surround Out
3	SPDIF Out
4	Line In
5	Line Out
6	Mic In

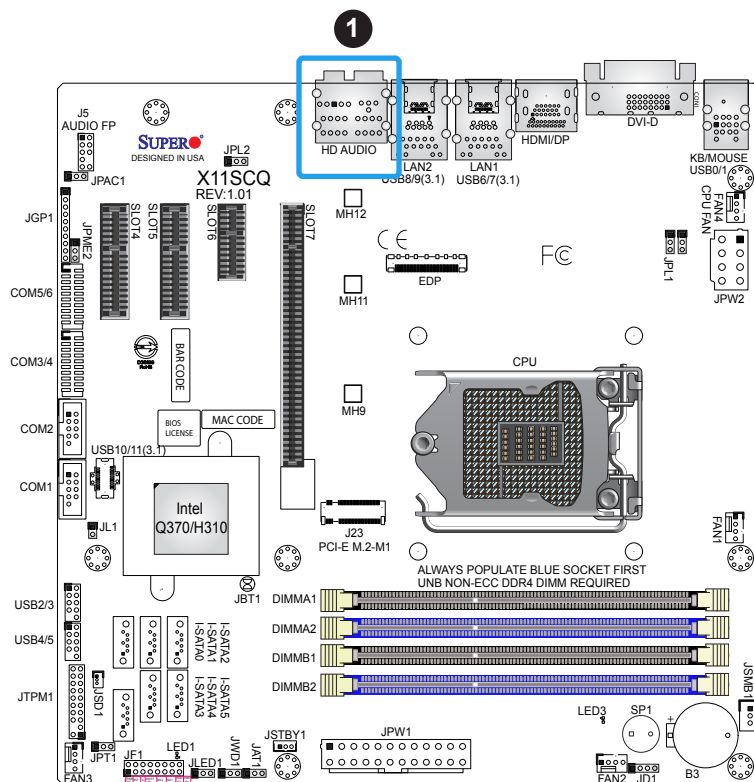

1. HD Audio Ports

General Purpose I/O Header

The JGP1 (General Purpose Input/Output) header is a general purpose I/O expander on a pin header via the SMBus. Each pin can be configured to be an input pin or output pin in 2.54mm pitch. The GPIO is controlled via the PCA9554APW 8-bit GPIO expansion from PCH SMBus. The base address is 0xEFA0. The expander slave address is 0x70 for WRITE and 0x71 for READ.. See the table below for pin definitions.

JGP1 Header Pin Definitions	
Pin#	Definition
1	+5V
2	GP0
3	GP1
4	GP2
5	GP3
6	GP4
7	GP5
8	GP6
9	GP7
10	Ground

Internal Speaker/Buzzer

The Internal Speaker/Buzzer (SP1) is used to provide audible indications for various beep codes.

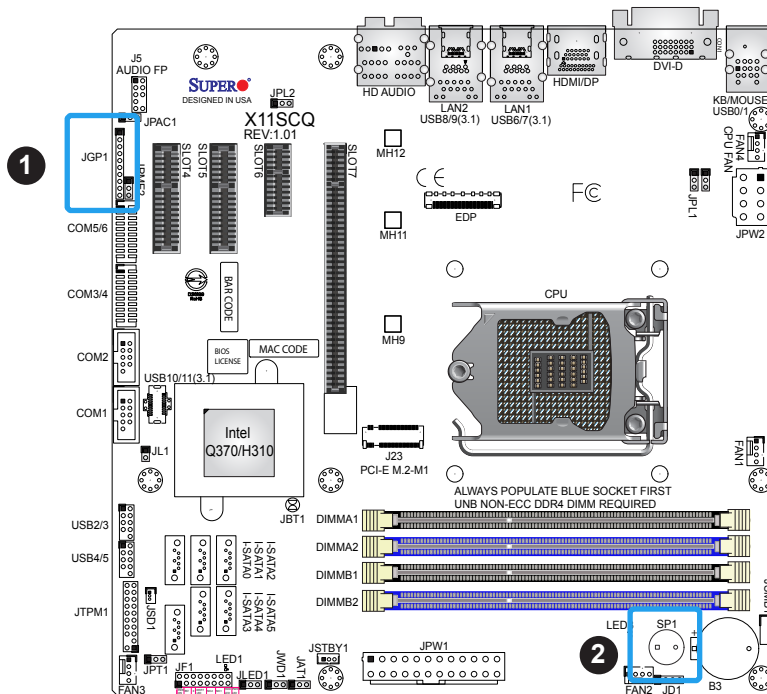

1. General Purpose Header
2. Speaker/Buzzer

Standby Power

The Standby Power header is located at JSTBY1 on the motherboard. Refer to the table below for pin definitions.

Standby Power Pin Definitions	
Pin#	Definition
1	+5V Standby
2	Ground
3	No Connection

Onboard Power LED

An onboard Power LED header is located at JLED1. This Power LED header is connected to the Front Control Panel located at JF1 to indicate the status of the system power. See the table below for pin definitions.

Onboard Power LED Pin Definitions	
Pins	Definition
1	VCC
2	No Connection
3	Connection to PWR LED on JF1

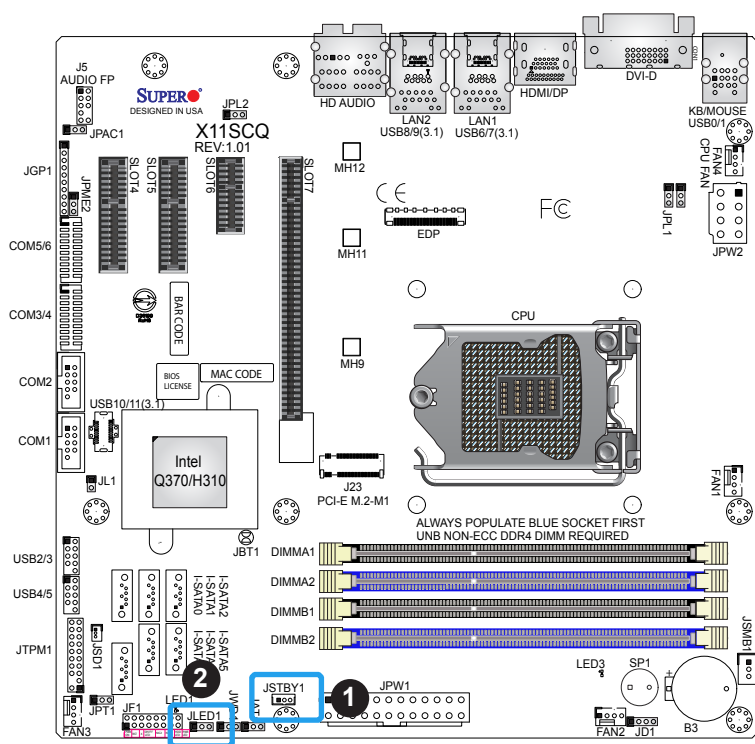

1. Standby Power
2. Onboard Power LED

COM Headers

The motherboard has four COM headers (COM1, COM2, COM3/4, COM5/6) that provide six serial connections. COM1 and COM2 provide one serial connection each, while COM3/4 and COM5/6 provide two each, utilizing Supermicro PN: CBL-CUSB-0984 (not included).

COM Header (COM1, COM2) Pin Definitions			
Pin#	Definition	Pin#	Definition
1	DCD	6	DSR
2	RXD	7	RTS
3	TXD	8	CTS
4	DTR	9	RI
5	Ground	10	N/A

COM Header (COM3/4, COM5/6) Pin Definitions			
Pin#	Definition	Pin#	Definition
1	DCD4	2	DSR4
3	RXD4	4	RTS4
5	TXD4	6	CTS4
7	DTR4	8	RI4_N
9	GND	10	N/A
11	DCD3	12	DSR3
13	RXD3	14	RTS3
15	TXD3	16	CTS3
17	DTR3	18	RI3_N
19	GND	20	N/A

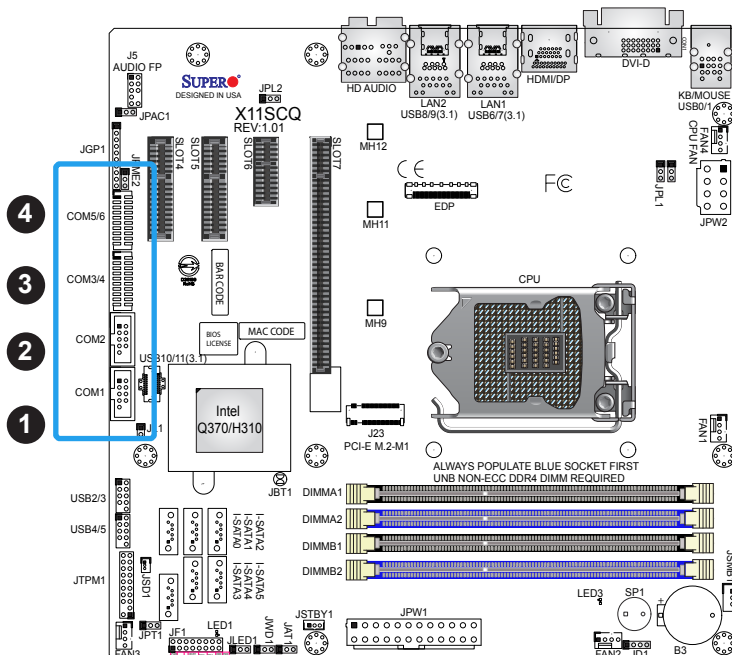
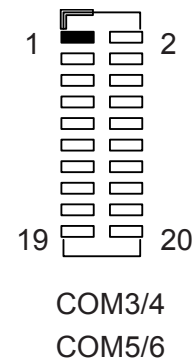
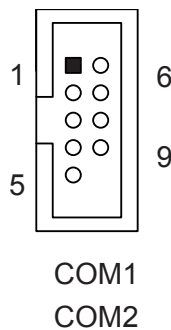

1. COM1
2. COM2
3. COM3/4
4. COM5/6

Fan Headers

There are four 4-pin fan headers on the motherboard. Although these are 4-pin fan headers, pins 1-3 are backward compatible with traditional 3-pin fans. The onboard fan speeds are controlled by Thermal Management (via Hardware Monitoring) in the BIOS. When using Thermal Management setting, please use all 3-pin fans or all 4-pin fans.

Fan Header Pin Definitions	
Pin#	Definition
1	Ground (Black)
2	+12V (Red)
3	Tachometer
4	PWM Control

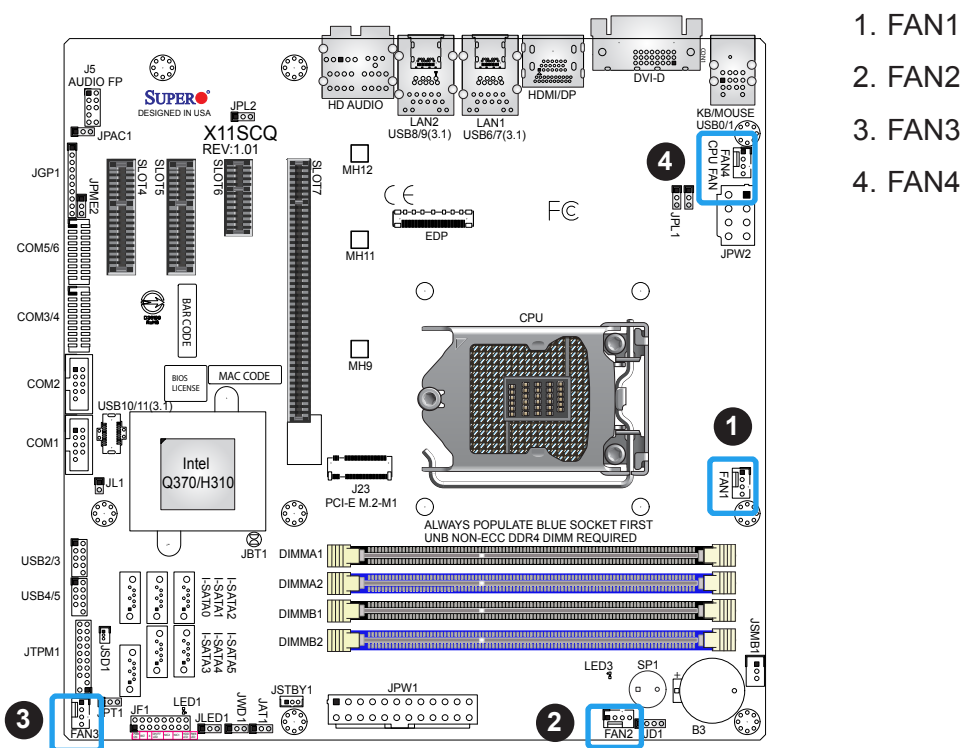

2.8 Jumper Settings

How Jumpers Work

To modify the operation of the motherboard, jumpers can be used to choose between optional settings. Jumpers create shorts between two pins to change the function of the connector. Pin 1 is identified with a square solder pad on the printed circuit board. See the diagram at right for an example of jumping pins 1 and 2. Refer to the motherboard layout page for jumper locations.

 **Note:** On two-pin jumpers, Closed means the jumper is on and Open means the jumper is off the pins.

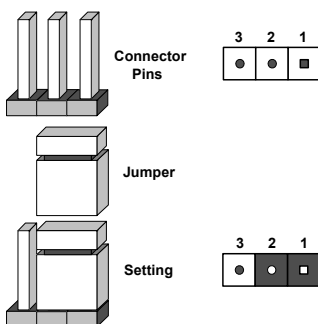

CMOS Clear

JBT1 is used to clear CMOS, which will also clear any passwords. Instead of pins, this jumper consists of contact pads to prevent accidentally clearing the contents of CMOS.

To Clear CMOS

1. First power down the system and unplug the power cord(s).
2. Remove the cover of the chassis to access the motherboard.
3. Remove the onboard battery from the motherboard.
4. Short the CMOS pads with a metal object such as a small screwdriver for at least four seconds.
5. Remove the screwdriver (or shorting device).
6. Replace the cover, reconnect the power cord(s), and power on the system.



Note: Clearing CMOS will also clear all passwords.



JBT1 contact pads

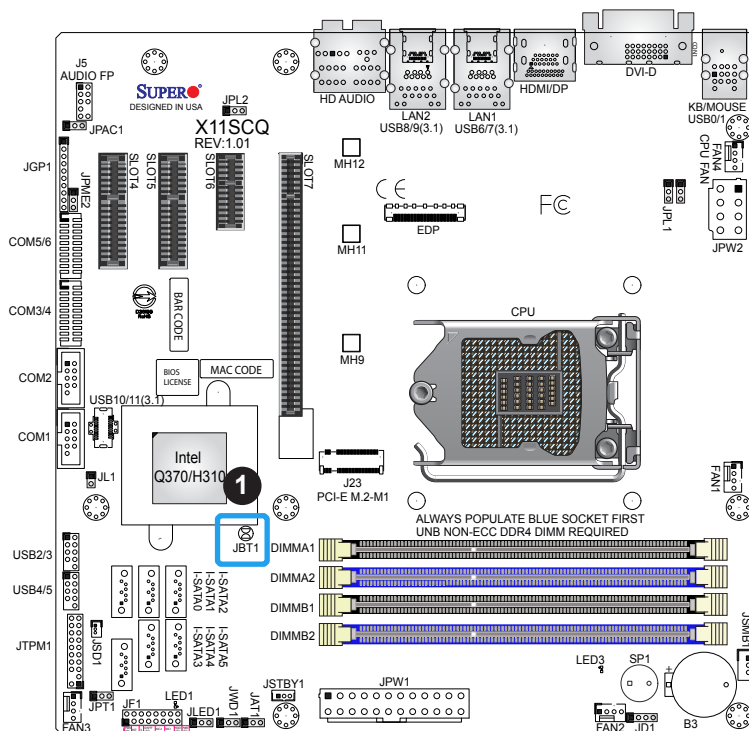

1. Clear CMOS

Force-On (ATX/AT)

Use jumper JAT1 to put the motherboard into either ATX or AT mode. Setting it to AT mode enables the motherboard to power on as soon as power is supplied, even if a power loss previously occurred. The default setting is ATX Mode.

Force-On (ATX/AT) Jumper Settings	
Jumper Setting	Definition
Pins 1-2	ATX (Default)
Pins 2-3	AT

ME Manufacturing Mode

Close JPME2 to bypass SPI flash security and force the system to use the Manufacturing Mode, which will allow the user to flash the system firmware from a host server to modify system settings. Refer to the table below for jumper settings.

Manufacturing Mode Jumper Settings	
Jumper Setting	Definition
Pins 1-2	Normal (Default)
Pins 2-3	Manufacturing Mode

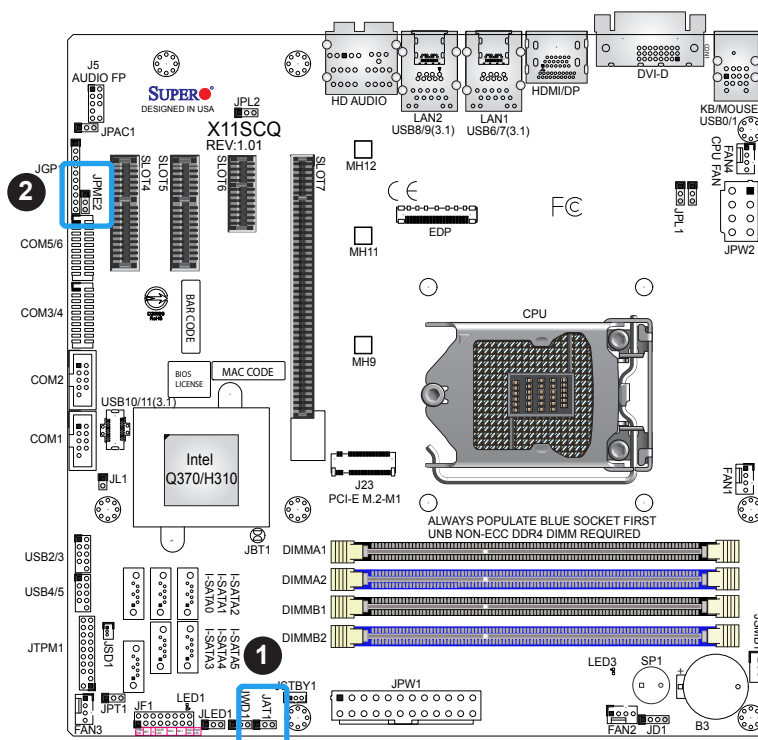

1. Power Mode Select
2. Manufacturing Mode

LAN Port Enable/Disable

Use JPL1 to enable or disable LAN1, and JPL2 to enable or disable LAN2. The default setting is Enabled.

LAN Port Enable/Disable Jumper Settings	
Jumper Setting	Definition
Pins 1-2	Enabled (Default)
Pins 2-3	Disabled

Onboard Audio Enable/Disable

JPAC1 allows you to enable or disable the onboard audio support. The default position is on pins 1-2 to enable onboard audio connections. Refer to the table below for jumper settings.

Audio Enable/Disable Jumper Settings	
Jumper Setting	Definition
Pins 1-2	Enabled (Default)
Pins 2-3	Disabled

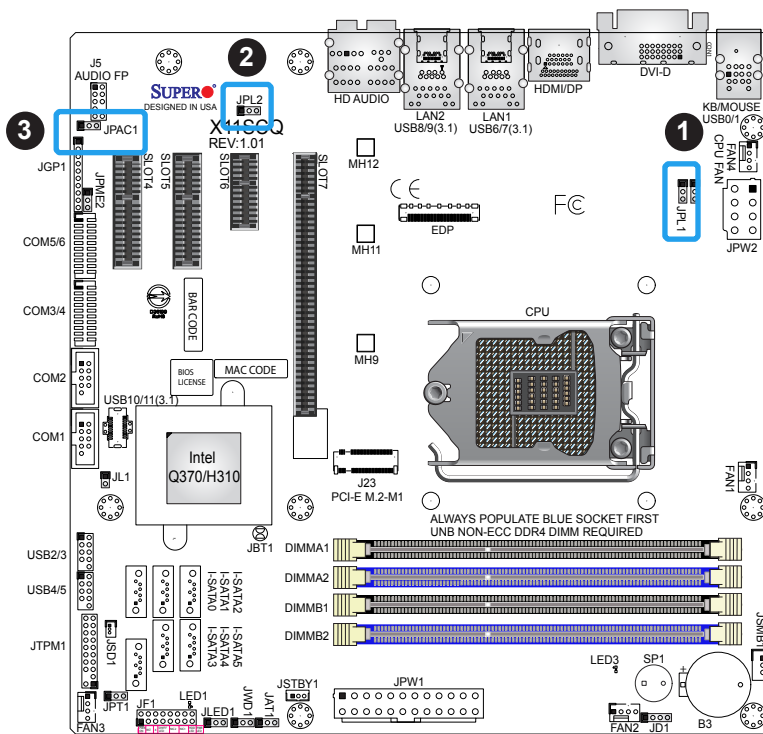

1. LAN1 Enable/Disable
2. LAN2 Enable/Disable
3. Audio Enable/Disable

Watch Dog

JWD1 controls the Watch Dog function. Watch Dog is a monitor that can reboot the system when a software application hangs. Jumping pins 1-2 will cause Watch Dog to reset the system if an application hangs. Jumping pins 2-3 will generate a non-maskable interrupt signal for the application that hangs. Watch Dog must also be enabled in BIOS. The default setting is Reset.

 **Note:** When Watch Dog is enabled, users need to write their own application software to disable it.

Watch Dog Jumper Settings	
Jumper Setting	Definition
Pins 1-2	Reset (Default)
Pins 2-3	NMI
Open	Disabled

Onboard TPM2.0 Enable/Disable (X11SCQ only)

Use JPT1 to enable or disable support for the onboard TPM 2.0 module. This jumper is not available on the X11SCQ-L. The default setting is Enabled.

TPM Enable/Disable Jumper Settings	
Jumper Setting	Definition
Pins 1-2	Enabled (Default)
Pins 2-3	Disabled

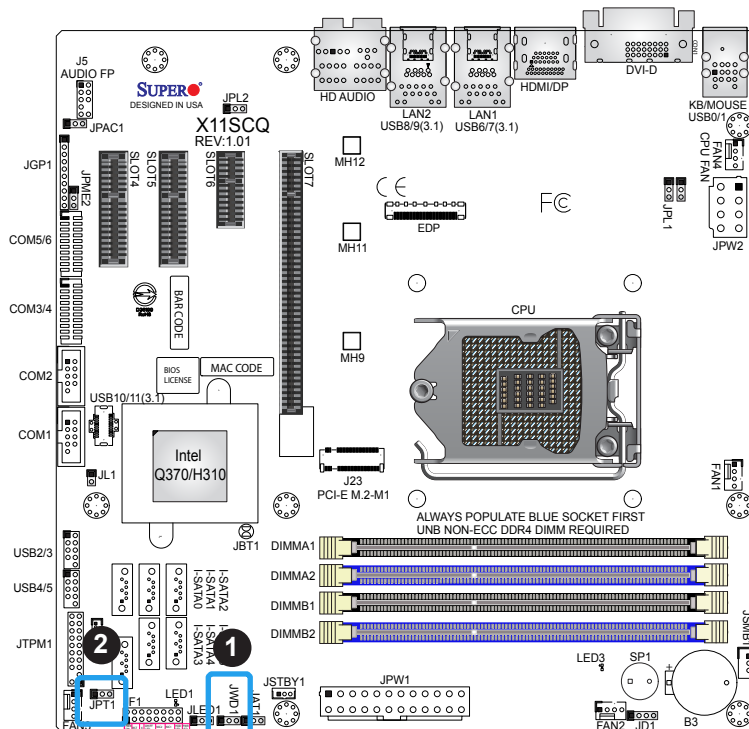

1. Watch Dog Timer
2. TPM Enable

2.9 LED Indicators

Power LED

LED1 is an Onboard Power LED. When this LED is lit, it means power is present on the motherboard. In suspend mode, this LED will blink on and off. Turn off the system and unplug the power cord(s) before removing or installing components.

Onboard Power LED Indicator	
LED Color	Definition
Off	System Off (power cable not connected)
Green	System On

Standby Power LED

LED3 is the Standby Power LED. When the LED is green, the system is on standby.

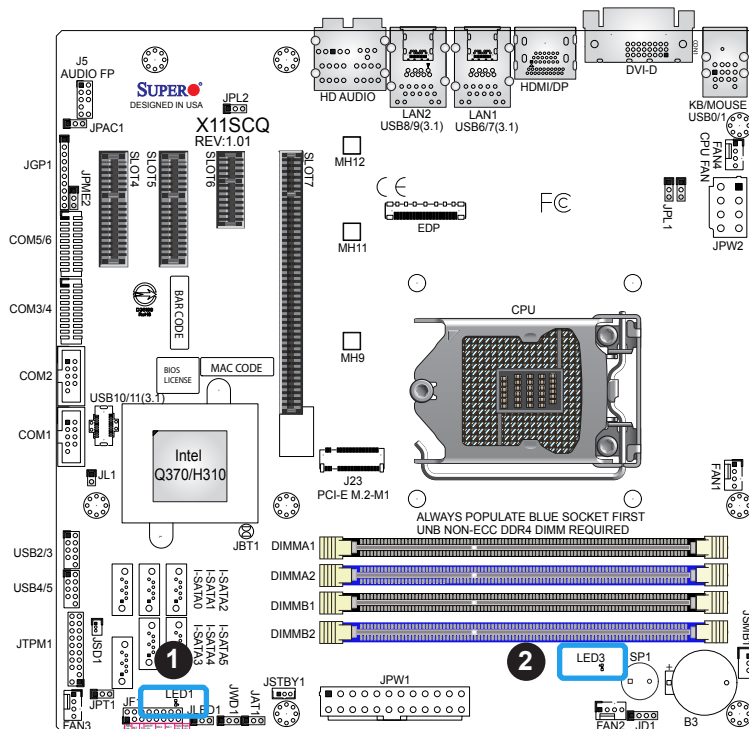

1. Power LED
2. Standby Power LED

Chapter 3

Troubleshooting

3.1 Troubleshooting Procedures

Use the following procedures to troubleshoot your system. If you have followed all of the procedures below and still need assistance, refer to the 'Technical Support Procedures' and/or 'Returning Merchandise for Service' section(s) in this chapter. Always disconnect the AC power cord before adding, changing or installing any non hot-swap hardware components.

Before Power On

1. Check that the standby power LED on the motherboard is on.
2. Make sure that the power connector is connected to your power supply.
3. Make sure that no short circuits exist between the motherboard and chassis.
4. Disconnect all cables from the motherboard, including those for the keyboard and mouse.
5. Remove all add-on cards.
6. Install a CPU, a heatsink, and connect the internal speaker and the power LED to the motherboard. Check all jumper settings as well. (Make sure that the heatsink is fully seated.)
7. Use the correct type of onboard CMOS battery as recommended by the manufacturer. To avoid possible explosion, do not install the CMOS battery upside down.

No Power

1. Make sure that no short circuits exist between the motherboard and the chassis.
2. Verify that all jumpers are set to their default positions.
3. Check that the 115V/230V switch on the power supply is properly set.
4. Turn the power switch on and off to test the system.
5. The battery on your motherboard may be old. Check to verify that it still supplies ~3VDC. If it does not, replace it with a new one.

No Video

1. If the power is on but you have no video, remove all the add-on cards and cables.
2. Use the speaker to determine if any beep codes exist. Refer to Appendix A for details on beep codes.

System Boot Failure

If the system does not display POST (Power-On-Self-Test) or does not respond after the power is turned on, check the following:

1. Check for any error beeps from the motherboard speaker.
 - If there is no error beep, try to turn on the system without DIMM modules installed. If there is still no error beep, replace the motherboard.
 - If there are error beeps, clear the CMOS settings by unplugging the power cord and contacting both pads on the CMOS Clear Jumper (JBT1). Refer to chapter 2.
2. Remove all components from the motherboard, especially the DIMM modules. Make sure that system power is on and that memory error beeps are activated.
3. Turn on the system with only one DIMM module installed. If the system boots, check for bad DIMM modules or slots by following the Memory Errors Troubleshooting procedure in this Chapter.

Memory Errors

1. Make sure that the DIMM modules are properly and fully installed.
2. Confirm that you are using the correct memory. Also, it is recommended that you use the same memory type and speed for all DIMMs in the system. [See Section 2.4 for memory details.](#)
3. Check for bad DIMM modules or slots by swapping modules between slots and noting the results.
4. Check the power supply voltage 115V/230V switch.

Losing the System's Setup Configuration

1. Make sure that you are using a high quality power supply. A poor quality power supply may cause the system to lose the CMOS setup information. Refer to Section 1.6 for details on recommended power supplies.
2. The battery on your motherboard may be old. Check to verify that it still supplies ~3VDC. If it does not, replace it with a new one.
3. If the above steps do not fix the setup configuration problem, contact your vendor for repairs.

When the System Becomes Unstable

A. If the system becomes unstable during or after OS installation, check the following:

1. CPU/BIOS support: Make sure that your CPU is supported and that you have the latest BIOS installed in your system.
2. Memory support: Make sure that the memory modules are supported by testing the modules using memtest86 or a similar utility.



Note: Click on the Tested Memory List link on the motherboard product page to see a list of supported memory.

3. HDD support: Make sure that all hard disk drives (HDDs) work properly. Replace the bad HDDs with good ones.
4. System cooling: Check the system cooling to make sure that all heatsink fans and CPU/system fans, etc., work properly. Check the hardware monitoring settings to make sure that the CPU and system temperatures are within the normal range. Also check the front panel Overheat LED and make sure that it is not on.
5. Adequate power supply: Make sure that the power supply provides adequate power to the system. Make sure that all power connectors are connected. Please refer to our website for more information on the minimum power requirements.
6. Proper software support: Make sure that the correct drivers are used.

B. If the system becomes unstable before or during OS installation, check the following:

1. Source of installation: Make sure that the devices used for installation are working properly, including boot devices such as CD.
2. Cable connection: Check to make sure that all cables are connected and working properly.

3. Using the minimum configuration for troubleshooting: Remove all unnecessary components (starting with add-on cards first), and use the minimum configuration (but with a CPU and a memory module installed) to identify the trouble areas. Refer to the steps listed in Section A above for proper troubleshooting procedures.
4. Identifying bad components by isolating them: If necessary, remove a component in question from the chassis, and test it in isolation to make sure that it works properly. Replace a bad component with a good one.
5. Check and change one component at a time instead of changing several items at the same time. This will help isolate and identify the problem.
6. To find out if a component is good, swap this component with a new one to see if the system will work properly. If so, then the old component is bad. You can also install the component in question in another system. If the new system works, the component is good and the old system has problems.

3.2 Technical Support Procedures

Before contacting Technical Support, please take the following steps. Also, note that as a motherboard manufacturer, we do not sell directly to end-users, so it is best to first check with your distributor or reseller for troubleshooting services. They should know of any possible problem(s) with the specific system configuration that was sold to you.

1. Please review the 'Troubleshooting Procedures' and 'Frequently Asked Questions' (FAQs) sections in this chapter or see the FAQs on our website before contacting Technical Support.
2. BIOS upgrades can be downloaded from our website. **Note:** Not all BIOS can be flashed depending on the modifications to the boot block code.
3. If you still cannot resolve the problem, include the following information when contacting us for technical support:
 - Motherboard model and PCB revision number
 - BIOS release date/version (this can be seen on the initial display when your system first boots up)
 - System configuration

An example of a Technical Support form is posted on our website.

Distributors: For immediate assistance, please have your account number ready when contacting our technical support department by e-mail.

3.3 Frequently Asked Questions

Question: What type of memory does my motherboard support?

Answer: The X11SCQ supports up to 64GB of Non-ECC DDR4 UDIMM with speeds of up to 2666MHz in four slots. The X11SCQ-L supports up to 32GB of Non-ECC DDR4 UDIMM with speeds of up to 2666MHz in two slots.

Question: How do I update my BIOS?

Answer: It is recommended that you **do not** upgrade your BIOS if you are not experiencing any problems with your system. Updated BIOS files are located on our website at http://www.supernmicro.com/ResourceApps/BIOS_IPMI_Intel.html. Please check our BIOS warning message and the information on how to update your BIOS on our website. Select your motherboard model and download the BIOS file to your computer. Also, check the current BIOS revision to make sure that it is newer than your BIOS before downloading. Please unzip the BIOS file onto a USB stick. (Note: The USB stick doesn't have to be bootable, but has to be formatted with the FAT/FAT32 file system.) Plug the USB stick into any USB port, boot to the Build-In UEFI Shell, select the item in the boot menu by pressing F11 key during boot up, and type FLASH.nsh BIOSname#.### to start the BIOS update. After the message indicating BIOS update has completed, perform an A/C power cycle.

Question: Why can't I turn off the power using the momentary power on/off switch?

Answer: The instant power off function is controlled in BIOS by the Power Button Mode setting. When the On/Off feature is enabled, the motherboard will have instant off capabilities as long as the BIOS has control of the system. When the Standby or Suspend feature is enabled or when the BIOS is not in control such as during memory count (the first screen that appears when the system is turned on), the momentary on/off switch must be held for more than four seconds to shut down the system. This feature is required to implement the ACPI features on the motherboard.

3.4 Battery Removal and Installation

Battery Removal

To remove the onboard battery, follow the steps below:

1. Power off your system and unplug your power cable.
2. Using a tool such as a pen or a small screwdriver, push the battery lock outwards to unlock it. Once unlocked, the battery will pop out from the holder.
3. Remove the battery.

Proper Battery Disposal

Please handle used batteries carefully. Do not damage the battery in any way; a damaged battery may release hazardous materials into the environment. Do not discard a used battery in the garbage or a public landfill. Please comply with the regulations set up by your local hazardous waste management agency to dispose of your used battery properly.

Battery Installation

1. To install an onboard battery, follow the steps 1 and 2 above and continue below:
2. Identify the battery's polarity. The positive (+) side should be facing up.
3. Insert the battery into the battery holder and push it down until you hear a click to ensure that the battery is securely locked.



Note: When replacing a battery, be sure to only replace it with the same type.

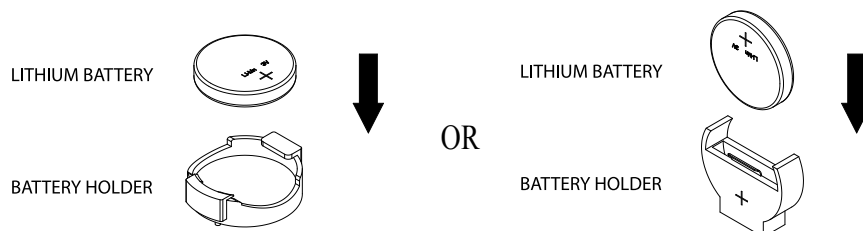

3.5 Returning Merchandise for Service

A receipt or copy of your invoice marked with the date of purchase is required before any warranty service will be rendered. You can obtain service by calling your vendor for a Returned Merchandise Authorization (RMA) number. When returning to the manufacturer, the RMA number should be prominently displayed on the outside of the shipping carton and mailed prepaid or hand-carried. Shipping and handling charges will be applied for all orders that must be mailed when service is complete.

For faster service, RMA authorizations may be requested online at <http://www.supermicro.com/RmaForm/>.

This warranty only covers normal consumer use and does not cover damages incurred in shipping or from failure due to the alteration, misuse, abuse or improper maintenance of products.

During the warranty period, contact your distributor first for any product problems.

Chapter 4

BIOS

4.1 Introduction

This chapter describes the AMIBIOS™ Setup utility for the X11SCQ/-L motherboard. The BIOS is stored on a chip and can be easily upgraded using a flash program.



Note: Due to periodic changes to the BIOS, some settings may have been added or deleted and might not yet be recorded in this manual. Please refer to the Manual Download area of our website for any changes to BIOS that may not be reflected in this manual.

Starting the Setup Utility

To enter the BIOS Setup Utility, hit the <Delete> key while the system is booting up. (In most cases, the <Delete> key is used to invoke the BIOS setup screen. There are a few cases when other keys are used, such as <F1>, <F2>, etc.) Each main BIOS menu option is described in this manual.

The Main BIOS screen has two main frames. The left frame displays all the options that can be configured. “Grayed-out” options cannot be configured. The right frame displays the key legend. Above the key legend is an area reserved for a text message. When an option is selected in the left frame, it is highlighted in white. Often a text message will accompany it. (Note that BIOS has default text messages built in. We retain the option to include, omit, or change any of these text messages.) Settings printed in **Bold** are the default values.

A " ►" indicates a submenu. Highlighting such an item and pressing the <Enter> key will open the list of settings within that submenu.

The BIOS setup utility uses a key-based navigation system called hot keys. Most of these hot keys (<F1>, <Enter>, <ESC>, <Arrow> keys, etc.) can be used at any time during the setup navigation process.

4.2 Main Setup

When you first enter the AMI BIOS setup utility, you will enter the Main setup screen. You can always return to the Main setup screen by selecting the Main tab on the top of the screen. The Main BIOS setup screen is shown below and the following features will be displayed:

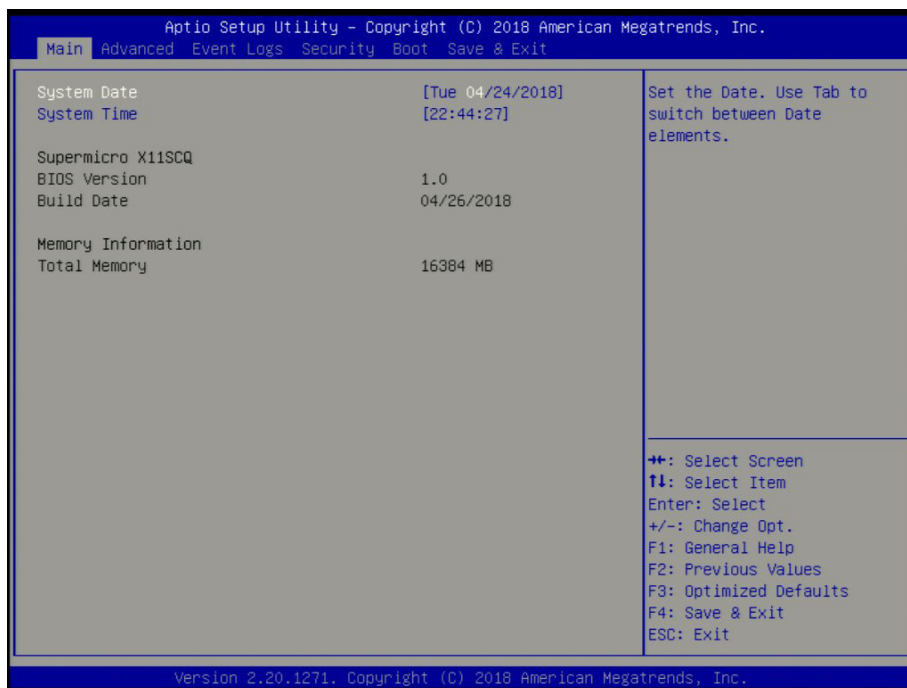

System Date/System Time

Use this feature to change the system date and time. Highlight *System Date* or *System Time* using the arrow keys. Enter new values using the keyboard. Press the <Tab> key or the arrow keys to move between fields. The date must be entered in MM/DD/YYYY format. The time is entered in HH:MM:SS format.

 **Note:** The time is in the 24-hour format. For example, 5:30 P.M. appears as 17:30:00. The date's default value is the BIOS build date after RTC reset.

Supermicro X11SCQ

BIOS Version

This feature displays the version of the BIOS ROM used in the system.

Build Date

This feature displays the date when the version of the BIOS ROM used in the system was built.

Memory Information

Total Memory

This feature displays the total size of memory available in the system.

4.3 Advanced

Use this menu to configure advanced settings.

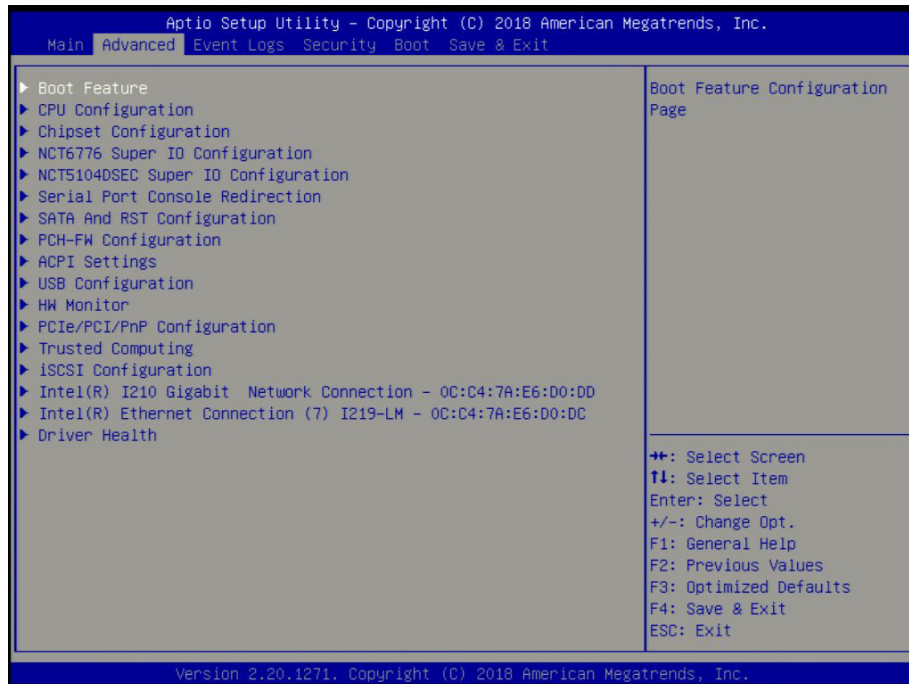

Warning: Take caution when changing the Advanced settings. An incorrect value, a very high DRAM frequency or an incorrect BIOS timing setting may cause the system to malfunction. When this occurs, restore to default manufacturer settings.

► Boot Feature

Fast Boot

Enable this feature to reduce the time it takes to boot the system. A minimal set of devices will be initialized during boot up. The options are **Disabled** and **Enabled**.

Quiet Boot

Use this feature to select the screen display between POST messages or the OEM logo at bootup. Select **Disabled** to display the POST messages. Select **Enabled** to display the OEM logo instead of the normal POST messages. The options are **Disabled** and **Enabled**.

Bootup NumLock State

Use this feature to set the Power-on state for the Numlock key. The options are **Off** and **On**.

Option ROM Messages

Use this feature to set the display mode for the Option ROM. The options are **Force BIOS** and **Keep Current**.

Wait For "F1" If Error

This feature forces the system to wait until the F1 key is pressed if an error occurs. The options are Disabled and **Enabled**.

Re-try Boot

If this feature is enabled, the BIOS will automatically reboot the system from a specified boot device after its initial boot failure. The options are **Disabled**, and Legacy Boot, and EFI Boot.

Watch Dog Function

If enabled, the Watch Dog timer will allow the system to reboot when it is inactive for more than five minutes. The options are **Disabled** and Enabled.

AC Loss Policy Depend on

Use this feature to set the power state after a power outage. Select Power Off for the system power to remain off after a power loss. Select Power On for the system power to be turned on after a power loss. Select Last State to allow the system to resume its last power state before a power loss. The options are Stay Off, Power On, and **Last State**.

Power Button Function

This feature controls how the system shuts down when the power button is pressed. Select 4 Seconds Override for the user to power off the system after pressing and holding the power button for four seconds or longer. Select Instant Off to instantly power off the system as soon as the user presses the power button. The options are **Instant Off** and 4 Seconds Override.

DeepSx Power Policies

Use this feature to configure the Advanced Configuration and Power Interface (ACPI) settings for the system. Enable S4-S5 to power off the whole system except the power supply unit (PSU) and keep the power button alive so that the user can wake up the system by using an USB keyboard or mouse. The options are **Disabled** and Enabled in S4-S5.

Install Windows 7 USB Support

Enable this feature to use the USB keyboard and mouse during the Windows 7 installation since the native XHCI driver support is unavailable. Use a SATA optical drive as a USB drive. USB CD/DVD drives are not supported. Disable this feature after the XHCI driver has been installed in Windows. The options are **Disabled** and Enabled.

►CPU Configuration

The following CPU information will display:

- CPU Signature
- Microcode Patch
- MAX CPU Speed

- Min CPU Speed
- CPU Speed
- Processor Cores
- Hyper Threading Technology
- VMX
- SMX/TXT
- 64-bit
- EIST Technology
- CPU C3 state
- CPU C6 state
- CPU C7 state
- CPU C8 state
- CPU C9 state
- CPU C10 state
- L1 Data Cache
- L1 Instruction Cache
- L2 Cache
- L3 Cache
- L4 Cache

C6DRAM

Select Enabled to activate moving the DRAM contents to PRM memory when the CPU is in the C6 state. The options are Disabled and **Enabled**.

Hardware Prefetcher

If set to Enable, the hardware prefetcher will prefetch streams of data and instructions from the main memory to the L2 cache to improve CPU performance. The options are Disabled and **Enabled**.

Adjacent Cache Line Prefetch

The CPU prefetches the cache line for 64 bytes if this feature is set to Disabled. The CPU prefetches both cache lines for 128 bytes as comprised if this feature is set to Enabled. The options are Disabled and **Enabled**.

Intel (VMX) Virtualization Technology

Use this feature to enable the Vanderpool Technology. This technology allows the system to run several operating systems simultaneously. The options are Disabled and **Enabled**.

Active Processor Cores

This feature determines how many CPU cores will be activated for each CPU. When all is selected, all cores in the CPU will be activated. (Please refer to Intel's website for more information.) The options are **All** or the number of available CPU cores (1~7).

AES

Select Enabled for Intel CPU Advanced Encryption Standard (AES) instructions support to enhance data integrity . The options are Disabled and **Enabled**.

Boot Performance Mode

This feature allows the user to select the performance state that the BIOS will set before the operating system handoff. The options are Power Saving, **Max Non-Turbo Performance**, and Turbo Performance.

Intel® SpeedStep™

Intel SpeedStep Technology allows the system to automatically adjust processor voltage and core frequency to reduce power consumption and heat dissipation. The options are Disabled and **Enabled**.

Intel® Speed Shift Technology

Use this feature to enable or disable Intel Speed Shift Technology support. When this feature is enabled, the Collaborative Processor Performance Control (CPPC) version 2 interface will be available to control CPU P-States. The options are Disabled and **Enabled**.

Turbo Mode (Availability Varies Depending on Installed CPU)

Select Enable for processor cores to run faster than the frequency specified by the manufacturer. The options are Disabled and **Enabled**.

Package Power Limit MSR Lock

Select Enabled to lock the package power limit for the model specific registers. The options are **Disabled** and Enabled.

Power Limit 1 Override

Select Enabled to support average power limit (PL1) override. The options are **Disabled** and **Enabled**.

Power Limit 1

Use this feature to configure the value for Power Limit 1. The value is in milli watts and the step size is 125mW. Use the number keys on your keyboard to enter the value. Enter 0 to use the manufacture default setting If the value is 0, the BIOS will set PL1 as 1.25* TDP. This feature is hidden when Power Limit 1 Override is Disabled.

Power Limit 1 Time Window

Use this feature to define the Running Average Power Limit (RAPL) time window 1 in miliseconds. The default setting is **0**. Use the "+" or "-" keys to define the setting. This feature is hidden when Power Limit 1 Override is Disabled.

Power Limit 2 Override

Select Enabled to support rapid power limit (PL2) override. The options are **Disabled** and **Enabled**.

Power Limit 2

Use this feature to configure the value for Power Limit 2. The value is in milli watts and the step size is 125mW. Use the number keys on your keyboard to enter the value. Enter 0 to use the manufacture default setting If the value is 0, the BIOS will set PL2 as 1.25* TDP.

1-Core Ratio Limit Override

This increases (multiplies) 1 clock speed in the CPU core in relation to the bus speed when one CPU core is active. Press "+" or "-" on your keyboard to change the value. Enter **35** to use the manufacture default setting.

2-Core Ratio Limit Override

This increases (multiplies) 2 clock speeds in the CPU core in relation to the bus speed when two CPU cores are active. Press "+" or "-" on your keyboard to change the value. Enter **34** to use the manufacture default setting.

3-Core Ratio Limit Override

This increases (multiplies) 3 clock speeds in the CPU core in relation to the bus speed when three CPU cores are active. Press "+" or "-" on your keyboard to change the value. Enter **34** to use the manufacture default setting.

4-Core Ratio Limit Override

This increases (multiplies) 4 clock speeds in the CPU core in relation to the bus speed when four CPU cores are active. Press "+" or "-" on your keyboard to change the value. Enter **33** to use the manufacture default setting.

5-Core Ratio Limit Override

This increases (multiplies) 5 clock speed in the CPU core in relation to the bus speed when five CPU core is active. Press "+" or "-" on your keyboard to change the value. Enter **33** to use the manufacture default setting.

6-Core Ratio Limit Override

This increases (multiplies) 6 clock speeds in the CPU core in relation to the bus speed when six CPU cores are active. Press "+" or "-" on your keyboard to change the value. Enter **32** to use the manufacture default setting.

C states

Use this feature to enable the C-State of the CPU. The options are Disabled and **Enabled**.

Enhanced C-states

Use this feature to enable the enhanced C-State of the CPU. The options are Disabled and **Enabled**.

C-State Auto Demotion

Use this feature to prevent unnecessary excursions into the C-states to improve latency. The options are Disabled, C1, C3, and **C1 and C3**.

C-State Un-demotion

This feature allows the user to enable or disable the un-demotion of C-State. The options are Disabled, C1, C3, and **C1 and C3**

Package C-State Demotion

Use this feature to enable or disable the Package C-State demotion. The options are **Disabled** and Enabled.

Package C-State Un-demotion

Use this feature to enable or disable the Package C-State un-demotion. The options are **Disabled** and Enabled.

CState Pre-Wake

This feature allows the user to enable or disable the C-State Pre-Wake. The options are Disabled and **Enabled**.

Package C State Limit

Use this feature to set the Package C-State limit. The options are C0/C1, C2, C3, C6, C7, C7s, C8, C9, C10, Cpu Default, and **Auto**.

► Chipset Configuration

Warning: Setting the wrong values in the sections below may cause the system to malfunction.

► System Agent (SA) Configuration

The following information will display:

- SA PCIe Code Version: 7.0.44.81
- VT-d: Supported

► Memory Configuration

Memory Configuration

- Memory RC Version
- Memory Frequency
- Memory Timing (tCL-tRCD-tRP-tRAS)
- DIMMA1
- DIMMA2
- DIMMB1
- DIMMB2

Maximum Memory Frequency

Use this feature to set the maximum memory frequency for onboard memory modules. The options are **Auto**, 1067, 1333, 1400, 1600, 1800, 1867, 2000, 2133, 2200, 2400, 2600, and 2667.

Max TOLUD

This feature sets the maximum TOLUD value, which specifies the "Top of Low Usable DRAM" memory space to be used by internal graphics devices, GTT Stolen Memory, and TSEG, respectively, if these devices are enabled. The options are **Dynamic**, 1 GB, 1.25 GB, 1.5 GB, 1.75 GB, 2 GB, 2.25 GB, 2.5 GB, 2.75 GB, 3 GB, 3.25 GB, and 3.5 GB.

Memory Scrambler

Use this feature to enable or disable memory scrambler support. The options are Disable and **Enable**.

MRC Fast Boot

Use this feature to enable or disable fast path through the memory reference code. The options are Disable and **Enable**.

► Graphics Configuration

Graphics Configuration

- IGFX VBIOS Version
- IGFX GOP Version

Primary Display

Use this feature to select the primary video display. The options are **Auto**, IGFX, PEG, and PCI.

Primary PEG

Use this feature to select which graphics device should be the the primary PEG. The **default** is CPU SLOT7 PCI-E 3.0 X16.

Primary PCIE

Use this feature to select whether the device in SLOT4, SLOT5, or SLOT6 should be the primary PCI-E graphics display. The options are **Auto**, PCH SLOT4 PCI-E 3.0 X4, PCH SLOT5 PCI-E 3.0 X4, and PCH SOLT6 PCI-E 3.0 X1.

Internal Graphics

Select Auto to keep an internal graphics device installed on an expansion slot supported by the CPU to be automatically enabled. The options are **Auto**, Disable, and Enable.

GTT Size

Use this feature to set the memory size to be used by the graphics translation table (GTT). The options are 2MB, 4MB, and **8MB**.

Aperture Size

Use this feature to set the Aperture size, which is the size of system memory reserved by the BIOS for graphics device use. The options are 128MB, **256MB**, 512MB, 1024MB, and 2048MB.

DVMT Pre-Allocated

Dynamic Video Memory Technology (DVMT) allows dynamic allocation of system memory to be used for video devices to ensure best use of available system memory based on the DVMT 5.0 platform. The options are 0M, **32M**, 64M, 4M, 8M, 12M, 16M, 20M, 24M, 28M, 36M, 40M, 44M, 48M, 52M, 56M, and 60M.

DVMT Total Gfx Mem

Use this feature to set the total memory size to be used by internal graphics devices based on the DVMT 5.0 platform. The options are 128MB, **256MB**, and MAX.

VDD Enable

Enabling this feature will force VDD in the BIOS. The options are **Enable** and Disable.

PM Support

Enable this feature to activate Power Management BIOS support. The options are **Enable** and Disable.

PAVP Enable

Protected Audio Video Path (PAVP) decodes Intel integrated graphics encrypted video. The options are Disable and **Enable**.

Cdynmax Clamping Enable

Enable this feature to activate Cdynmax Clamping. The options are **Enable** and Disable.

Graphics Clock Frequency

Use this feature to set the internal graphics clock frequency. The options are 337.5 Mhz, 450 Mhz, 540 Mhz, and **675 Mhz**.

Skip CD Clock Init in S3 resume

Use this feature to enable skipping of the full CD initialization. If set to Disabled, the full CD clock will initialize. The options are Enable and **Disable**.

►DMI/OPI Configuration

The following DMI information will display:

DMI: X4 Gen 3 (X11SCQ) or X4 Gen 2 (X11SCQ-L)

DMI Link ASPM Control

Use this feature to set the ASPM (Active State Power Management) state on the SA (System Agent) side of the DMI Link. The options are Disable, L0s, L1, and **L0sL1**.

DMI Extended Sync Control

Use this feature to enable or disable the DMI extended synchronization. The options are Enable and **Disable**.

DMI De-emphasis Control

Use this feature to configure the De-emphasis control on DMI. The options are -6 dB and **-3.5 dB**.

► PEG Port Configuration**CPU SLOT7 PCI-E 3.0 X16****SLOT7 Enable Root Port**

Use this feature to enable or disable the PCI Express Graphics (PEG) device in the port specified by the user. The options are Disable, Enable, and **Auto**.

SLOT7 Max Link Speed

Use this feature to select PCI-E support for the device installed on SLOT7. The options are **Auto**, Gen 1, Gen 2, and Gen 3.

SLOT7 ASPM

This feature appears if a graphics card is plugged in Slot 7. Use this feature to control ASPM support for the device in Slot 7. The options are Disable, **Auto**, ASPM L0s, ASPM L1, and ASPM L0sL1.

SLOT7 ASPM L0s

This feature appears if ASPM L0s is selected in the feature above. Use this feature to enable PCIe ASPM L0s. The options are Root Port Only, Endpoint Port Only, and **Both Root and Endpoint Ports**.

SLOT7 Slot Power Limit Value

Use this feature to set the upper limit on the power supplied by the PCIE slot. Press "+" or "-" on your keyboard to change this value. The default setting is **75**.

SLOT7 Slot Power Limit Scale

Use this feature to select the scale used for the slot power limit value. The options are **1.0x**, 0.1x, 0.01x, and 0.001x.

Program PCIe ASPM After OpROM

PCIe ASPM, the Active State Power Management for PCI-Express slots, is a power management protocol used to manage power consumption of serial link devices installed on PCI-E slots during a prolonged off-peak time. If this feature is set to Enabled, PCI-E ASPM will be programmed after OPROM. If set to Disabled, the PCI-E ASPM will be programmed before OPROM. The options are **Disabled** and Enabled.

►GT - Power Management Control

RC6 (Render Standby)

Use this feature to enable render standby support. The options are Disabled and **Enabled**.

Maximum GT frequency

Use this feature to define the Maximum GT frequency. Choose between 33MHz (RPN) and 1200MHz (RP0). Any value beyond this range will be clipped to its min/max supported by the CPU. The options are **Default Max Frequency**, 100MHz, 150MHz, 200MHz, 250MHz, 300MHz, 350MHz, 400MHz, 450MHz, 500MHz, 550MHz, 600MHz, 650MHz, 700MHz, 750MHz, 800MHz, 8520MHz, 900MHz, 950MHz, 1000MHz, 1050MHz, 1100MHz, 1150MHz, and 1200MHz.

Disable Turbo GT frequency

Use this feature to disable Turbo GT frequency. If set to Enabled, Turbo GT frequency becomes disabled. If set to Disabled, GT frequency limiters will be removed. The options are Enable and **Disable**.

VT-d

Select Enabled to activate Intel Virtualization Technology support for Direct I/O VT-d by reporting the I/O device assignments to VMM through the DMAR ACPI Tables. This feature offers fully-protected I/O resource-sharing across the Intel platforms, providing the user with greater reliability, security and availability in networking and data-sharing. The options are Disable and **Enable**.

SW Guard Extensions

Select Enabled to activate the Software Guard Extensions (SGX). The options are Disabled, Enabled, and **Software Controlled**.

Select Owner EPOCH input type

There are three Owner EPOCH modes (each EPOCH is 64 bit). The options are **No Change in Owner EPOCHs**, Change to New Random Owner EPOCHs, and Manual User Defined Owner EPOCHs.

PRMRR Size

This BIOS must reserve a contiguous region of Processor Reserved Memory (PRM) in the Porcessor Reserved Memory Range Register (PRMRR). This feature appears if SW Guard Extensions is set to Enabled. The options are 32MB, 64MB, and **128MB**.

GNA Device (B0:D8:F0)

Use this feature to enable SA GNA device. The options are **Enable** and Disable.

X2APIC Opt Out

Use this feature to enable or disable X2APIC Opt Out. The options are **Disable** or Enable.

► PCH-IO Configuration

The following PCH-IO information will display:

- PCH SKU Name
- Stepping

► PCI Express Configuration

DMI Link ASPM Control

Use this feature to set the ASPM (Active State Power Management) state on the SA (System Agent) side of the DMI Link. The options are Disabled, L0s, L1, L0sL1, and **Auto**.

Peer Memory Write Enable

Use this feature to enable or disable peer memory write. The options are **Disabled** and Enabled.

- PCH SLOT4 PCI-E 3.0 X4
- PCH SLOT5 PCI-E 3.0 X4
- PCH SLOT6 PCI-E 3.0 X1

ASPM

Use this feature to activate the Active State Power Management (ASPM) level for a PCI-E device. Select Auto for the system BIOS to automatically set the ASPM level based on the system configuration. Select Disabled to disable ASPM support. The options are Disabled, L0s, L1, L0sL1, and **Auto**.

L1 Substates

Use this feature to set the PCI Express L1 Substates. The options are Disabled, L1.1, and **L1.1 & L1.2**.

PTM

Use this feature to enable or disable Precision Time Measurement. The options are Disabled and **Enabled**.

DPC

Use this feature to enable or disable Downstream Port Containment. The options are Disabled and **Enabled**.

EDPC

Use this feature to enable or disable rootport extensions for Downstream Port Containment. The options are Disabled and **Enabled**.

PCIe Speed

Use this feature to select the PCI Express port speed. The options are **Auto**, Gen1, Gen2, and Gen3.

Frontside Audio Mode

Use this feature to select the frontside audio mode. The options are **HD Audio** and AC'97.

PCIe PLL SSC

Use this feature to enable or disable PCIe PLL SSC. The options are **Disabled** and Enabled.

►NCT6776 Super IO Configuration

The following Super IO information will display:

- Super IO Chip NCT6776

►Serial Port 1 Configuration**Serial Port 1**

Select Enabled to enable the selected onboard serial port. The options are Disabled and **Enabled**.

Device Settings

This feature displays the status of a serial port specified by the user.

Change Settings

This feature specifies the base I/O port address and the Interrupt Request address of a serial port specified by the user. Select Auto to allow the BIOS to automatically assign the base I/O and IRQ address. The options are **Auto**, (IO=3F8h; IRQ=4;), (IO=3F8h; IRQ=3, 4, 5, 6, 7, 9, 10, 11, 12;), (IO=2F8h; IRQ=3, 4, 5, 6, 7, 9, 10, 11, 12;), (IO=3E8h; IRQ=3, 4, 5, 6, 7, 9, 10, 11, 12;), and (IO=2E8h; IRQ=3, 4, 5, 6, 7, 9, 10, 11, 12;).

►Serial Port 2 Configuration**Serial Port 2**

Select Enabled to enable the selected onboard serial port. The options are Disabled and **Enabled**.

Device Settings

This feature displays the status of a serial port specified by the user.

Change Settings

This feature specifies the base I/O port address and the Interrupt Request address of a serial port specified by the user. Select Auto to allow the BIOS to automatically assign the base I/O and IRQ address. The options are **Auto**, (IO=2F8h; IRQ=3;), (IO=3F8h; IRQ=3, 4, 5, 6, 7, 9, 10, 11, 12;), (IO=2F8h; IRQ=3, 4, 5, 6, 7, 9, 10, 11, 12;), (IO=3E8h; IRQ=3, 4, 5, 6, 7, 9, 10, 11, 12;), and (IO=2E8h; IRQ=3, 4, 5, 6, 7, 9, 10, 11, 12;).

►NCT5104DSEC Super IO Configuration (for COM3/4/5/6)

The following Super IO information will display:

- Super IO Chip NCT5104DSEC

►Serial Port 1 Configuration (COM3)**Serial Port**

Select Enabled to enable the selected onboard serial port. The options are Disabled and **Enabled**.

Device Settings

This feature displays the status of a serial port specified by the user.

Change Settings

This feature specifies the base I/O port address and the Interrupt Request address of a serial port specified by the user. Select Auto to allow the BIOS to automatically assign the base I/O and IRQ address. The options are **Auto**, (IO=240h; IRQ=7;), (IO=240h; IRQ=3, 4, 5, 6, 7, 10, 11, 12;), (IO=248h; IRQ=3, 4, 5, 6, 7, 10, 11, 12;), (IO=250h; IRQ=3, 4, 5, 6, 7, 10, 11, 12;), and (IO=258h; IRQ=3, 4, 5, 6, 7, 10, 11, 12;).

► Serial Port 2 Configuration (COM4)

Serial Port

Select Enabled to enable the selected onboard serial port. The options are Disabled and Enabled.

Device Settings

This feature displays the status of a serial port specified by the user.

Change Settings

This feature specifies the base I/O port address and the Interrupt Request address of a serial port specified by the user. Select Auto to allow the BIOS to automatically assign the base I/O and IRQ address. The options are **Auto**, (IO=248h; IRQ=7;), (IO=240h; IRQ=3, 4, 5, 6, 7, 10, 11, 12;), (IO=248h; IRQ=3, 4, 5, 6, 7, 10, 11, 12;), (IO=250h; IRQ=3, 4, 5, 6, 7, 10, 11, 12;), and (IO=258h; IRQ=3, 4, 5, 6, 7, 10, 11, 12;).

► Serial Port 3 Configuration (COM5)

Serial Port

Select Enabled to enable the selected onboard serial port. The options are Disabled and Enabled.

Device Settings

This feature displays the status of a serial port specified by the user.

Change Settings

This feature specifies the base I/O port address and the Interrupt Request address of a serial port specified by the user. Select Auto to allow the BIOS to automatically assign the base I/O and IRQ address. The options are **Auto**, (IO=250h; IRQ=7;), (IO=240h; IRQ=3, 4, 5, 6, 7, 10, 11, 12;), (IO=248h; IRQ=3, 4, 5, 6, 7, 10, 11, 12;), (IO=250h; IRQ=3, 4, 5, 6, 7, 10, 11, 12;), and (IO=258h; IRQ=3, 4, 5, 6, 7, 10, 11, 12;).

► Serial Port 4 Configuration (COM6)

Serial Port

Select Enabled to enable the selected onboard serial port. The options are Disabled and Enabled.

Device Settings

This feature displays the status of a serial port specified by the user.

Change Settings

This feature specifies the base I/O port address and the Interrupt Request address of a serial port specified by the user. Select Auto to allow the BIOS to automatically assign the base I/O and IRQ address. The options are **Auto**, (IO=258h; IRQ=7;), (IO=240h; IRQ=3, 4, 5, 6, 7, 10, 11, 12;), (IO=248h; IRQ=3, 4, 5, 6, 7, 10, 11, 12;), (IO=250h; IRQ=3, 4, 5, 6, 7, 10, 11, 12;), and (IO=258h; IRQ=3, 4, 5, 6, 7, 10, 11, 12;).

►Serial Port Console Redirection

COM1 ~ COM6

Console Redirection

Select Enabled to enable the specific COM Port for Console Redirection, which will allow a client machine to be connected to a host machine at a remote site for networking. The options are **Disabled** and Enabled.

**If the feature above is set to Enabled, the following features will become available for configuration:*

►Console Redirection Settings

Terminal Type

This feature allows the user to select the target terminal emulation type for Console Redirection. Select VT100 to use the ASCII Character set. Select VT100+ to add color and function key support. Select ANSI to use the Extended ASCII Character Set. Select VT-UTF8 to use UTF8 encoding to map Unicode characters into one or more bytes. The options are VT100, **VT100+**, VT-UTF8, and ANSI.

Bits per second

Use this feature to set the transmission speed for a serial port used in Console Redirection. Make sure that the same speed is used in the host computer and the client computer. A lower transmission speed may be required for long and busy lines. The options are 9600, 19200, 38400, 57600, and **115200** (bits per second).

Data Bits

Use this feature to set the data transmission size for Console Redirection. The options are 7 and 8.

Parity

A parity bit can be sent along with regular data bits to detect data transmission errors. Select Even if the parity bit is set to 0, and the number of 1's in data bits is even. Select Odd if the parity bit is set to 0, and the number of 1's in data bits is odd. Select None if you do not want to send a parity bit with your data bits in transmission. Select Mark to add a mark as a parity bit to be sent along with the data bits. Select Space to add a Space as a parity bit to be sent with your data bits. The options are **None**, Even, Odd, Mark, and Space.

Stop Bits

A stop bit indicates the end of a serial data packet. Select 1 Stop Bit for standard serial data communication. Select 2 Stop Bits if slower devices are used. The options are **1** and **2**.

Flow Control

Use this feature to set the flow control for Console Redirection to prevent data loss caused by buffer overflow. Send a "Stop" signal to stop sending data when the receiving buffer is full. Send a "Start" signal to start sending data when the receiving buffer is empty. The options are **None** and Hardware RTS/CTS.

VT-UTF8 Combo Key Support

Select Enabled to enable VT-UTF8 Combination Key support for ANSI/VT100 terminals. The options are Disabled and **Enabled**.

Recorder Mode

Select Enabled to capture the data displayed on a terminal and send it as text messages to a remote server. The options are **Disabled** and Enabled.

Resolution 100x31

Select Enabled for extended-terminal resolution support. The options are Disabled and **Enabled**.

Legacy OS Redirection Resolution

Use this feature to select the number of rows and columns used in Console Redirection for legacy OS support. The options are 80x24 and **80x25**.

Putty KeyPad

This feature selects Function Keys and KeyPad settings for Putty, which is a terminal emulator designed for the Windows OS. The options are **VT100**, LINUX, XTERMR6, SCO, ESCN, and VT400.

Redirection After BIOS POST

Use this feature to enable or disable legacy console redirection after BIOS POST. When set to BootLoader, legacy console redirection is disabled before booting the OS. When set to Always Enable, legacy console redirection remains enabled when booting the OS. The options are **Always Enable** and BootLoader.

AMT SOL Console Redirection

Select Enabled to use the SOL port for Console Redirection. The options are **Disabled** and Enabled.

**If the feature above is set to Enabled, the following features are available for configuration:*

▶AMT SOL Console Redirection Settings

Use this feature to specify how the host computer will exchange data with the client computer, which is the remote computer used by the user.

AMT SOL Terminal Type

Use this feature to select the target terminal emulation type for Console Redirection. Select VT100 to use the ASCII Character set. Select VT100+ to add color and function key support. Select ANSI to use the Extended ASCII Character Set. Select VT-UTF8 to use UTF8 encoding to map Unicode characters into one or more bytes. The options are VT100, **VT100+**, VT-UTF8, and ANSI.

AMT SOL Bits per second

Use this feature to set the transmission speed for a serial port used in Console Redirection. Make sure that the same speed is used in the host computer and the client computer. A lower transmission speed may be required for long and busy lines. The options are 9600, 19200, 38400, 57600, and **115200** (bits per second).

AMT SOL Data Bits

Use this feature to set the data transmission size for Console Redirection. The options are 7 and **8**.

AMT SOL Parity

A parity bit can be sent along with regular data bits to detect data transmission errors. Select Even if the parity bit is set to 0, and the number of 1's in data bits is even. Select Odd if the parity bit is set to 0, and the number of 1's in data bits is odd. Select None if you do not want to send a parity bit with your data bits in transmission. Select Mark to add a mark as a parity bit to be sent along with the data bits. Select Space to add a Space as a parity bit to be sent with your data bits. The options are **None**, Even, Odd, Mark and Space.

AMT SOL Stop Bits

A stop bit indicates the end of a serial data packet. Select 1 Stop Bit for standard serial data communication. Select 2 Stop Bits if slower devices are used. The options are **1** and 2.

AMT SOL Flow Control

Use this feature to set the flow control for Console Redirection to prevent data loss caused by buffer overflow. Send a "Stop" signal to stop sending data when the receiving buffer is full. Send a "Start" signal to start sending data when the receiving buffer is empty. The options are **None** and Hardware RTS/CTS.

AMT SOL VT-UTF8 Combo Key Support

Select Enabled to enable VT-UTF8 Combination Key support for ANSI/VT100 terminals. The options are Disabled and **Enabled**.

AMT SOL Recorder Mode

Select Enabled to capture the data displayed on a terminal and send it as text messages to a remote server. The options are **Disabled** and Enabled.

AMT SOL Resolution 100x31

Select Enabled for extended-terminal resolution support. The options are Disabled and **Enabled**.

AMT SOL Legacy OS Redirection Resolution

Use this feature to select the number of rows and columns used in Console Redirection for legacy OS support. The options are 80x24 and **80x25**.

AMT SOL Putty KeyPad

This feature selects Function Keys and KeyPad settings for Putty, which is a terminal emulator designed for the Windows OS. The options are **VT100**, LINUX, XTERMR6, SCO, ESCN, and VT400.

AMT SOL Redirection After BIOS POST

Use this feature to enable or disable legacy console redirection after BIOS POST. When set to BootLoader, legacy console redirection is disabled before booting the OS. When set to Always Enable, legacy console redirection remains enabled when booting the OS. The options are **Always Enable** and BootLoader.

Legacy Console Redirection**Redirection COM Port**

Use this feature to select a COM port to display redirection of Legacy OS and Legacy OPROM messages. The options are **COM1**, COM2, COM3, COM4, COM5, COM6, and AMT SOL.

Serial Port for Out-of-Band Management/Windows Emergency Management Services (EMS)

This submenu allows the user to configure Console Redirection settings to support Out-of-Band Serial Port management.

Console Redirection

Select Enabled to use a COM port selected by the user for EMS Console Redirection. The options are **Disabled** and Enabled.

****If the feature above is set to Enabled, the following features are available for configuration:***

► Console Redirection Settings

This feature allows the user to specify how the host computer will exchange data with the client computer, which is the remote computer used by the user.

Out-of-Band Mgmt Port

The feature selects a serial port in a client server to be used by the Microsoft Windows Emergency Management Services (EMS) to communicate with a remote host server. The options are **COM1**, COM2, COM3, COM4, COM5, COM6, and AMT SOL.

Terminal Type

Use this feature to select the target terminal emulation type for Console Redirection. Select VT100 to use the ASCII character set. Select VT100+ to add color and function key support. Select ANSI to use the extended ASCII character set. Select VT-UTF8 to use UTF8 encoding to map Unicode characters into one or more bytes. The options are VT100, VT100+, **VT-UTF8**, and ANSI.

Bits per second

This feature sets the transmission speed for a serial port used in Console Redirection. Make sure that the same speed is used in the host computer and the client computer. A lower transmission speed may be required for long and busy lines. The options are 9600, 19200, 57600, and **115200** (bits per second).

Flow Control

Use this feature to set the flow control for Console Redirection to prevent data loss caused by buffer overflow. Send a "Stop" signal to stop sending data when the receiving buffer is full. Send a "Start" signal to start sending data when the receiving buffer is empty. The options are **None**, Hardware RTS/CTS, and Software Xon/Xoff.

Data Bits

Use this feature to set the data transmission size for Console Redirection. The options are 7 and 8.

Parity

A parity bit can be sent along with regular data bits to detect data transmission errors. Select Even if the parity bit is set to 0, and the number of 1's in data bits is even. Select Odd if the parity bit is set to 0, and the number of 1's in data bits is odd. Select None if you do not want to send a parity bit with your data bits in transmission. Select Mark to add a mark as a parity bit to be sent along with the data bits. Select Space to add a Space as a parity bit to be sent with your data bits. The options are **None**, Even, Odd, Mark and Space.

Stop Bits

A stop bit indicates the end of a serial data packet. Select 1 Stop Bit for standard serial data communication. Select 2 Stop Bits if slower devices are used. The options are 1 and 2.

► SATA And RST Configuration**SATA Controller(s)**

This feature enables or disables the onboard SATA controller supported by the Intel PCH chip. The options are **Enabled** and Disabled.

SATA Mode Selection

Select AHCI to configure a SATA drive specified by the user as an AHCI drive. Select RAID to configure a SATA drive specified by the user as a RAID drive. The options are **AHCI** and RAID.

PCI-E M.2-M1

This feature appears if an M.2 device is plugged in and RAID is selected in the SATA Mode Selection feature. Use this feature to enable or disable RST PCIe storage remapping. The options are RST Controlled and **Not RST Controlled**.

Aggressive LPM Support

When this feature is set to Enable, the SATA AHCI controller manages the power usage of the SATA link. The controller will put the link in a low power mode during extended periods of I/O inactivity, and will return the link to an active state when I/O activity resumes. The options are Disabled and **Enabled**.

Storage Option ROM/UEFI Driver

Select UEFI to load the EFI driver for system boot. Select Legacy to load a legacy driver for system boot. The options are Do not Launch, EFI, and **Legacy**.

Serial ATA Port 0~5

This feature displays the information detected on the installed SATA drive on the particular SATA port.

- Model number of drive and capacity
- Software Preserve Support

Serial ATA Port 0~5 Hot Plug

Set this feature to Enable for hot plug support, which will allow the user to replace a SATA drive without shutting down the system. The options are Disabled and **Enabled**.

Serial ATA Port 0~5 Spin Up Device

Set this feature to enable or disable the PCH to initialize the device. The options are **Disabled** and Enabled.

Serial ATA Port 0~5 SATA Device Type

Use this feature to specify if the SATA port specified by the user should be connected to a Solid State Drive or a Hard Disk Drive. The options are **Hard Disk Drive** and Solid State Drive.

► PCH-FW Configuration

The following firmware information will display:

- ME Firmware Version
- ME Firmware Mode
- ME Firmware SKU

ME FW Image Re-Flash

Use this feature to update the Management Engine firmware. The options are **Disabled** and Enabled.

Manageability Features State

Enabled this feature to allow system administrators to configure the ME BIOS extension (MEBx) configuration settings. The options are Disabled and **Enabled**.

AMT BIOS Features

Disable this feature to deny access to the MEBx setup. The options are **Disabled** and Enabled.

****If the feature "AMT BIOS Features" above is set to Enabled, the AMT Configuration submenu will be available for configuration:***

▶AMT Configuration

ASF support

Use this feature to enable or disable Alert Standard Format support. This feature sends an alert about a potential issue when the operating system is in a sleep state. The options are Disabled and **Enabled**.

USB Provisioning of AMT

Use this feature to enable or disable USB provisioning. The options are **Disabled** and Enabled.

▶CIRCA Configuration

Activate Remote Assistance Process

Use this feature to activate Remote Assistance. Enabling this feature will also trigger the CIRCA boot. The options are **Disabled** and Enabled.

****If the feature "Activate Remote Assistance Process" above is set to Enabled, the feature below will be available for configuration:***

CIRCA Timeout

Use this feature to set the timeout value for MPS connection. Use 0 for the default timeout value of 60 seconds.

▶ASF Configuration

PET Progress

Use this feature to enable or disable PET Events Progress to receive PET Events alerts. The options are Disabled and **Enabled**.

WatchDog

Select Enabled to allow AMT to reset or power down the system if the operating system or BIOS hangs or crashes. The options are **Disabled** and Enabled.

OS Timer / BIOS Timer

These options appear if Watch Dog (above) is enabled. This is a timed delay in seconds, before a system power down or reset after a BIOS or operating system failure is detected. Enter the value in seconds.

ASF Sensors Table

Enable this feature for the ASF Sensor Table to be added into the ASF! ACPI table. The options are **Disabled** and Enabled.

► Secure Erase Configuration

Secure Erase mode

Select Real to securely erase a solid state drive. The options are **Simulated** and Real.

Force Secure Erase

Select Enabled to force a secure erase of the solid state drive on the next boot. The options are **Disabled** and Enabled.

► OEM Flags Settings

MEBx hotkey Pressed

Use this feature to specify whether the MEBx hotkey should be enabled during the system boot. The options are **Disabled** and Enabled.

MEBx Selection Screen

Use this feature to select the type of MEBx selection screen. Press 1 to enter the ME Configuration screen and 2 to initiate a remote connection. Network access must be activated for a remote connection. The options are **Disabled** and Enabled.

Hide Unconfigure ME Confirmation Prompt

Use this feature to hide the unconfigure ME confirmation prompt . The options are **Disabled** and Enabled.

MEBx OEM Debug Menu Enable

Use this feature to enable or disable the OEM debug menu in MEBx. The options are **Disabled** and Enabled.

Unconfigure ME

Use this feature to reset the MEBx password to default. The options are **Disabled** and Enabled.

► MEBx Resolution Settings

Non-UI Mode Resolution

Use this feature to specify the resolution for the non-UI text mode. The options are **Auto**, 80x25, and 100x31.

UI Mode Resolution

Use this feature to specify the resolution for the UI text mode. The options are **Auto**, 80x25, and 100x31.

Graphics Mode Resolution

Use this feature to specify the resolution for the graphics mode. The options are **Auto**, 640x480, 800x600, 1024x768.

►ACPI Settings

ACPI Sleep State

Use this feature to select the ACPI Sleep State that the system will enter into when the suspend button is activated. The options are Suspend Disabled and **S3 (Suspend to RAM)**.

WHEA Support

Select Enabled to support the Windows Hardware Error Architecture (WHEA) platform and provide a common infrastructure for the system to handle hardware errors within the Windows OS environment in order to reduce system crashes and enhance system recovery and health monitoring. The options are Disabled and **Enabled**.

High Precision Event Timer

Select Enabled to activate the High Precision Event Timer (HPET) that produces periodic interrupts at a much higher frequency than a Real-time Clock (RTC) does in synchronizing multimedia streams, providing smooth playback and reducing the dependency on other timestamp calculation devices, such as an x86 RDTSC Instruction embedded in the CPU. The High Performance Event Timer is used to replace the 8254 Programmable Interval Timer. The options are Disabled and **Enabled**.

Native PCIE Enable

Enable this feature to grant control of PCI Express Native hot plug, PCI Express Power Management Events, and PCI Express Capability Structure Control. The options are Disabled and **Enabled**.

Native ASPM

Select Enabled for the operating system to control the ASPM, or Disabled for the BIOS to control the ASPM. The options are Auto, Enabled, and **Disabled**.

Headless Mode Support

Select Enabled for the system to function without a keyboard, mouse, or monitor. The options are **Disabled** and Enabled.

Wake System from S5

Select Enabled for the system to wake from S5 on the hr:min:sec that is specified. The options are **Disabled** and Enabled.

► USB Configuration

USB Configuration

- USB Module Version
- USB Controllers
- USB Devices

Legacy USB Support

Select Enabled to support onboard legacy USB devices. Select Auto to disable legacy support if there are no legacy USB devices present. Select Disable to have all USB devices available for EFI applications only. The options are **Enabled**, Disabled, and Auto.

XHCI Hand-off

This is a work-around solution for operating systems that do not support XHCI (Extensible Host Controller Interface) hand-off. The XHCI ownership change should be claimed by the XHCI driver. The settings are **Enabled** and Disabled.

USB Mass Storage Driver Support

Select Enabled for USB mass storage device support. The options are Disabled and **Enabled**.

Port 60/64 Emulation

Select Enabled for I/O port 60h/64h emulation support, which in turn, will provide complete legacy USB keyboard support for the operating systems that do not support legacy USB devices. The options are Disabled and **Enabled**.

► HW Monitor

The following System Health information will be displayed:

- CPU Temperature
- PCH Temperature
- System Temperature
- Peripheral Temperature
- AOC/AOM/Riser Onboard Temperature

Fan Speed Control Mode

Use this feature to select the fan speed control mode. The options are **Standard** and Full Speed.

- FAN4
- FAN1
- FAN2
- FAN3
- Vcore
- 12V
- VDIMM
- 5VCC
- AVCC
- 3.3VCC
- VSB
- VBAT

► PCIe/PCI/PnP Configuration

Video

Use this feature to select the execution of the video OpROM. The options are Do not launch, UEFI, and **Legacy**.

PCI PERR/SERR Support

Use this feature to enable or disable the runtime event for PCI errors. The options are **Disabled** and Enabled.

Above 4G MMIO BIOS Assignment

Select Enabled to decode a PCI device that supports 64-bit in the space above 4G Address. The options are **Disabled** and Enabled.

BME DMA Mitigation

Use this feature to enable or disable the bus master attribute during PCI enumeration for PCI bridge after SMM is locked. The options are Enable and **Disable**.

PCIe/PCI/PnP Configuration

CPU SLOT7 PCI-E 3.0 X16 OPROM

Use this feature to select which firmware type to be loaded for the add-on card in this slot. The options are Disabled, **Legacy**, and EFI.

PCH SLOT6 PCI-E 3.0 X1 OPROM (PCI-E 2.0 X1 in X11SCQ-L)

Use this feature to select which firmware type to be loaded for the add-on card in this slot. The options are Disabled, **Legacy**, and EFI.

PCH SLOT5 PCI-E 3.0 X4 OPROM (PCI-E 2.0 X4 in X11SCQ-L)

Use this feature to select which firmware type to be loaded for the add-on card in this slot. The options are Disabled, **Legacy**, and EFI.

PCH SLOT4 PCI-E 3.0 X4 OPROM (Not Available on X11SCQ-L)

Use this feature to select which firmware type to be loaded for the add-on card in this slot. The options are Disabled, **Legacy**, and EFI.

PCI-E M.2-M1 OPROM (Not Available on X11SCQ-L)

Use this feature to select which firmware type to be loaded for the add-on card in this slot. The options are Disabled, **Legacy**, and EFI.

Onboard LAN1 SUPPORT

Use this feature to select which firmware function to be loaded for LAN Port1 used for system boot. The options are Disabled and **Enabled**.

Onboard LAN Option ROM Type

Use this feature to select which firmware type to be loaded for onboard LAN devices. The options **Legacy** and EFI. Select Legacy to display and configure the Onboard LAN1 ~ LAN2 Option ROM features.

Onboard LAN1 Option ROM

Use this feature to select which firmware function to be loaded for LAN Port1 used for system boot. The options are Disabled and **PXE**.

Onboard LAN2 Option ROM

Use this feature to select which firmware function to be loaded for LAN Port2 used for system boot. The options are **Disabled**, PXE, and iSCSI.

Network Stack

Select Enabled to enable PXE (Preboot Execution Environment) or UEFI (Unified Extensible Firmware Interface) for network stack support. The options are **Enabled** and Disabled.

****If the feature above is set to Enabled, the next six features will be available for configuration:***

Ipv4 PXE Support

Select Enabled to enable IPv4 PXE boot support. The options are Disabled and **Enabled**.

Ipv4 HTTP Support

Select Enabled to enable IPv4 HTTP boot support. The options are **Disabled** and Enabled.

Ipv6 PXE Support

Select Enabled to enable IPv6 PXE boot support. The options are Disabled and **Enabled**.

Ipv6 HTTP Support

Select Enabled to enable IPv6 HTTP boot support. The options are **Disabled** and Enabled.

IPSEC Certificate

The feature appears if Network Stack is enabled. Internet Protocol Security (IPSEC) offers a secure connection for remote computers using a secure tunnel. The options are **Enabled** and Disabled.

PXE boot wait time

Use this feature to specify the wait time to press the ESC key to abort the PXE boot. Press "+" or "-" on your keyboard to change the value. The default setting is **0**.

Media detect count

Use this option to specify the number of times media will be checked. Press "+" or "-" on your keyboard to change the value. The default setting is **1**.

►Trusted Computing (Onboard TPM2.0 only available on X11SCQ)**TPM20 Device Found**

Vendor: IFX

Firmware Version: 5.62

Security Device Support

If this feature and the TPM jumper on the motherboard are both set to Enabled, onboard security devices will be enabled for TPM support to enhance data integrity and network security. Please reboot the system for a change on this setting to take effect. The options are Disable and **Enable**.

The following TPM information will be displayed:

- Active PCR banks
- Available PCR banks

****If the feature "Security Device Support" is enabled, the following features are available for configuration:***

SHA-1 PCR Bank

Use this item to disable or enable the SHA-1 Platform Configuration Register (PCR) bank for the installed TPM device. The options are Disabled and **Enabled**.

SHA256 PCR Bank

Use this feature to disable or enable the SHA256 Platform Configuration Register (PCR) bank for the installed TPM device. The options are Disabled and **Enabled**.

Pending operation

Use this feature to schedule a TPM-related operation to be performed by a security device for system data integrity. Your system will reboot to carry out a pending TPM operation. The options are **None** and TPM Clear.

Platform Hierarchy

Use this feature to disable or enable platform hierarchy for platform protection. The options are Disabled and **Enabled**.

Storage Hierarchy

Use this feature to disable or enable storage hierarchy for cryptographic protection. The options are Disabled and **Enabled**.

Endorsement Hierarchy

Use this feature to disable or enable endorsement hierarchy for privacy control. The options are Disabled and **Enabled**.

TPM2.0 UEFI Spec Version

Use this feature to specify the TPM UEFI spec version. TCG 1.2 has support for Windows® 2012, Windows 8, and Windows 10. TCG 2 has support for Windows 10 or later. The options are TCG_1_2 and **TCG_2**.

Physical Presence Spec Version

Use this feature to select the PPI spec version. The options are 1.2 and **1.3**.

TPM 20 InterfaceType**PH Randomization**

Use this feature to disable or enable Platform Hierarchy (PH) Randomization. The options are **Disabled** and Enabled.

Device Select

Use this feature to select the TPM version. TPM 1.2 will restrict support to TPM 1.2 devices. TPM 2.0 will restrict support for TPM 2.0 devices. Select Auto to enable support for both versions. The options are TPM 1.2, TPM 2.0, **Auto**.

TXT support

Intel TXT (Trusted Execution Technology) helps protect against software-based attacks and ensures protection, confidentiality and integrity of data stored or created on the system. Use this feature to enable or disable TXT Support. The options are **Disabled** and **Enabled**.

► iSCSI Configuration

► **Add an Attempt**

► **Delete Attempts**

► **Change Attempt Order**

► Intel® I210 Gigabit Network Connection

► NIC Configuration

Link Speed

Use this feature to change the link speed and duplex for the current port. The options are **Auto Negotiated**, 10 Mbps Half, 10 Mbps Full, 100 Mbps Half, and 100 Mbps full.

Wake On LAN

Select enabled to wake the system with a magic packet. The options are **Disabled** and **Enabled**.

Blink LEDs

This feature allows the user to specify the duration for LEDs to blink. The range is from 0 ~ 15 seconds. The default setting is **0**.

This section displays the following port information:

- UEFI Driver
- Adapter PBA
- Device Name
- Chip Type
- PCI Device ID
- PCI Address
- Link Status
- MAC Address
- Virtual MAC Address

▶ Intel® Ethernet Network Connection (7) I219-LM

▶ NIC Configuration

Link Speed

Use this feature to change the link speed and duplex for the current port. The options are **Auto Negotiated**, 10 Mbps Half, 10 Mbps Full, 100 Mbps Half, and 100 Mbps full.

Wake On LAN

Select enabled to wake the system with a magic packet. The options are Disabled and **Enabled**.

Blink LEDs

This feature allows the user to specify the duration for LEDs to blink. The range is from 0 ~ 15 seconds. The default setting is **0**.

This section displays the following port information:

- UEFI Driver
- Adapter PBA
- Chip Type
- PCI Device ID
- PCI Address

Link Status

This feature displays the connection status for this network device.

- MAC Address

▶ Driver Health

This submenu displays the health status for the following network drivers and controllers.

▶ Intel® Gigabit 0.0.19 Healthy

Controller 9ab3e398 Child 0 Healthy

▶ Intel® PRO/1000 6.7.05 PCI-E Healthy

Controller 9ab3f798 Child 0 Healthy

Intel® I210 Gigabit Network Connection Healthy

4.4 Event Logs

Use this menu to configure event log settings.

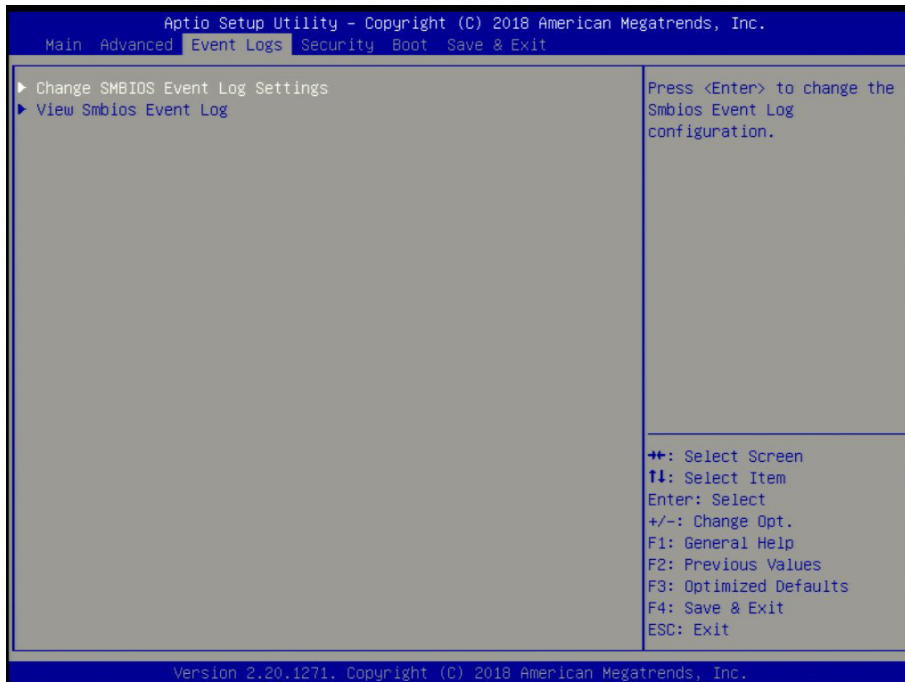

► Change SMBIOS Event Log Settings

Enabling/Disabling Options

SMBIOS Event Log

Change this feature to enable or disable all features of the SMBIOS Event Logging during system boot. The options are **Enabled** and Disabled.

Erasing Settings

Erase Event Log

Select Enabled to erase all error events in the SMBIOS (System Management BIOS) log before an event logging is initialized at bootup. The options are **No**, "Yes, Next reset," and "Yes, Every reset."

When Log is Full

Select Erase Immediately to immediately erase all errors in the SMBIOS event log when the event log is full. Select Do Nothing for the system to do nothing when the SMBIOS event log is full. The options are **Do Nothing** and Erase Immediately.

SMBIOS Event Log Standard Settings

Log System Boot Event

Select Enabled to log system boot events. The options are Enabled and **Disabled**.

MECI (Multiple Event Count Increment)

Enter the increment value for the multiple event counter. Enter a number between 1 to 255. The default setting is 1.

METW (Multiple Event Count Time Window)

This feature is used to determine how long (in minutes) the multiple event counter should wait before generating a new event log. Enter a number between 0 to 99. The default setting is **60**.



Note: Reboot the system for the changes to take effect.

►View SMBIOS Event Log

This feature allows the user to view the event in the SMBIOS event log. The following categories are displayed:

DATE/TIME/ERROR CODE/SEVERITY

4.5 Security

Use this menu to configure the security settings.

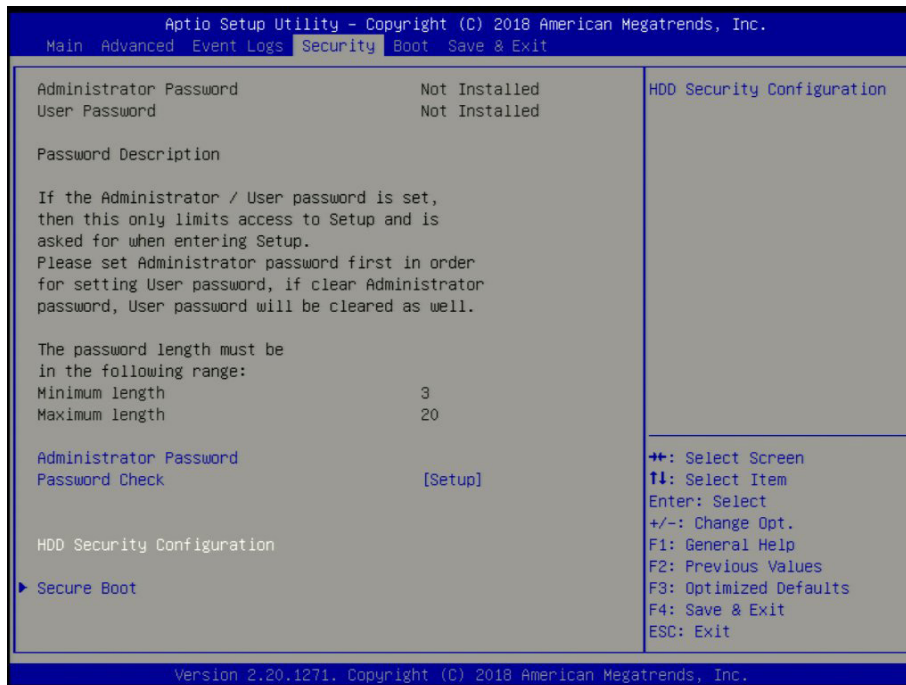

Administrator Password

Use this feature to set the administrator password which is required to enter the BIOS setup utility. The length of the password should be from three to 20 characters long.

Password Check

Select Setup for the system to check for a password at Setup. Select Always for the system to check for a password at bootup or upon entering the BIOS Setup utility. The options are **Setup** and Always.

HDD Security Configuration

This feature appears if a HDD is detected. Use this feature to set, modify, and clear user and master passwords for the HDD.

This feature displays the following HDD Password Configuration information:

- Security Supported
- Security Enabled
- Security Locked
- Security Frozen
- HDD User Pwd Status

- HDD Master Pwd Status

Set User Password

Use this feature to create a new user password for the HDD.

▶ Secure Boot

System Mode

Secure Boot

Attempt Secure Boot

Select Enable for secure boot support to ensure system security at bootup. The options are **Disabled** and Enabled.

Secure Boot Mode

This feature allows the user to select the desired secure boot mode for the system. The options are Standard and **Customized**.

****If Secure Boot Mode is set to Customized, Key Management features are available for configuration:***

CSM Support

This feature is for manufacturing debugging purposes. The options are Disabled and **Enabled**.

▶ Key Management

This submenu allows the user to configure the following Key Management settings.

Vendor Keys

Provision Factory Default Keys

Select Enabled to install the default Secure Boot keys set by the manufacturer. The options are **Disabled** and Enabled.

▶ Install Factory Default keys

Select Yes to install the default settings for all keys. The options are Yes and No.

▶ Reset to Setup Mode

Select Yes to delete all Secure Boot key databases and force the system to Setup Mode. The options are Yes and No.

▶ Save all Secure Boot variables

This feature allows the user to decide if all secure boot variables should be saved.

▶ **Enroll Efi Image**

This feature allows the image to run in Secure Boot mode.

Device Guard Ready

▶ **Remove 'UEFI CA' from DB**

Use this feature to remove the Microsoft UEFI CA certificate from the database. The options are Yes and No.

▶ **Restore DB defaults**

Select Yes to restore the DB defaults.

▶ **Platform Key (PK)**

This feature allows the user to configure the settings of the platform keys.

Update

Select Yes to load a factory default PK or No to load from a file on an external media.

▶ **Key Exchange Keys (KEK)**

Update

Select Yes to load a factory default KEK or No to load from a file on an external media.

Append

Select Yes to add the KEK from the manufacturer's defaults list to the existing KEK. Select No to load the KEK from a file. The options are Yes and No.

▶ **Authorized Signatures**

Update

Select Yes to load a factory default db or No to load from a file on an external media.

Append

Select Yes to add the db from the manufacturer's defaults list to the existing db. Select No to load the db from a file. The options are Yes and No.

▶ **Forbidden Signatures**

Update

Select Yes to load a factory default dbx or No to load from a file on an external media.

Append

Select Yes to add the dbx from the manufacturer's defaults list to the existing dbx. Select No to load the dbx from a file. The options are Yes and No.

► Authorized TimeStamps**Update**

Select Yes to load a factory default dbt or No to load from a file on an external media.

Append

Select Yes to add the dbt from the manufacturer's defaults list to the existing dbt. Select No to load the dbt from a file. The options are Yes and No.

► OsRecovery Signatures**Update**

Select Yes to load a factory default dbr or No to load from a file on an external media.

Append

Select Yes to add the dbr from the manufacturer's defaults list to the existing dbr. Select No to load the dbr from a file. The options are Yes and No.

4.7 Boot

Use this menu to configure boot settings:

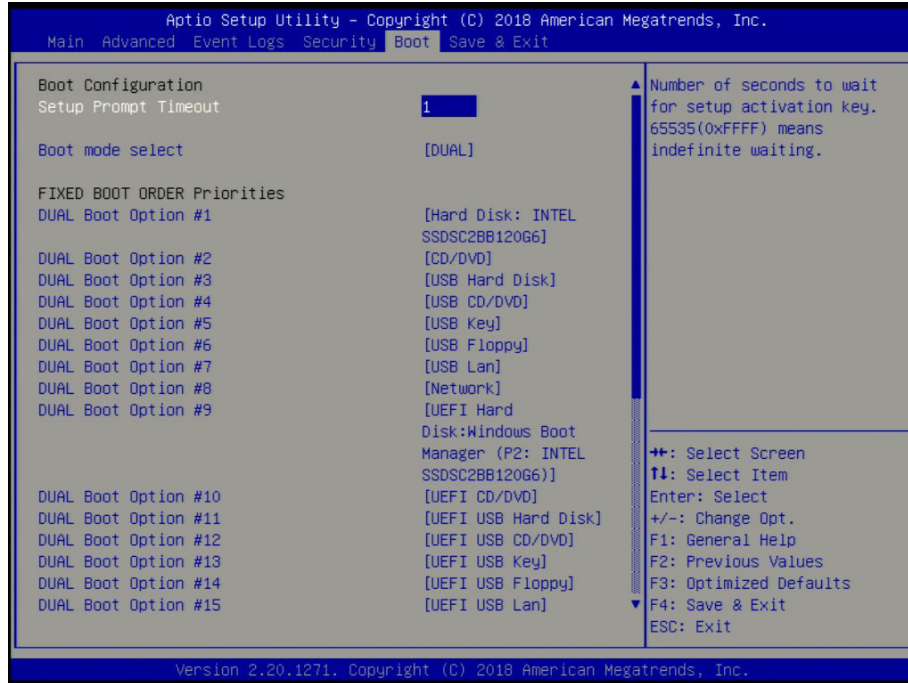

Setup Prompt Timeout

Use this feature to specify the length of time (the number of seconds) for the BIOS to wait before rebooting the system when the setup activation key is pressed. Enter the value of 65535 (0xFFFF) for the BIOS to wait indefinitely. The default setting is **1**.

Boot mode select

Use this feature to select the boot mode. The options are LEGACY, UEFI, and **DUAL**.

FIXED BOOT ORDER Priorities

This option prioritizes the order of bootable devices that the system to boot from. Press <Enter> on each entry from top to bottom to select devices.

- LEGACY/UEFI/DUAL Boot Option #1
- LEGACY/UEFI/DUAL Boot Option #2
- LEGACY/UEFI/DUAL Boot Option #3
- LEGACY/UEFI/DUAL Boot Option #4
- LEGACY/UEFI/DUAL Boot Option #5
- LEGACY/UEFI/DUAL Boot Option #6

- LEGACY/UEFI/DUAL Boot Option #7
- LEGACY/UEFI/DUAL Boot Option #8
- LEGACY/UEFI/DUAL Boot Option #9
- LEGACY/UEFI/DUAL Boot Option #10
- LEGACY/UEFI/DUAL Boot Option #11
- LEGACY/UEFI/DUAL Boot Option #12
- LEGACY/UEFI/DUAL Boot Option #13
- LEGACY/UEFI/DUAL Boot Option #14
- LEGACY/UEFI/DUAL Boot Option #15
- LEGACY/UEFI/DUAL Boot Option #16
- LEGACY/UEFI/DUAL Boot Option #17

▶ **Add New Boot Option**

Use this feature to select a boot device to add to the boot priority list.

▶ **Delete Boot Option**

Use this feature to select a boot device to delete from the boot priority list.

▶ **Add New Driver Option**

Use this feature to add a new EFI driver option to the driver order.

▶ **Delete Driver Option**

Use this feature to remove an EFI driver option from the driver order.

▶ **UEFI Hard Disk Drive BBS Priorities**

This feature appears if a UEFI storage media is detected.

- Boot Option # - This feature sets the system boot order of detected devices. The options are **[the list of detected boot device(s)]** and Disabled.

▶ **UEFI Application Boot Priorities**

- Boot Option # - This feature sets the system boot order of detected devices. The options are **[the list of detected boot device(s)]** and Disabled.

▶ **UEFI USB Key Drive BBS Priorities**

- Boot Option # - This feature sets the system boot order of detected devices. The options are **[the list of detected boot device(s)]** and Disabled.

▶ **Hard Disk Drive BBS Priorities**

This feature appears if any storage media is detected.

- Boot Option # - This feature sets the system boot order of detected devices. The options are **[the list of detected boot device(s)]** and Disabled.

▶ **USB Key Drive BBS Priorities**

- Boot Option # - This feature sets the system boot order of detected devices. The options are **[the list of detected boot device(s)]** and Disabled.

▶ **NETWORK Drive BBS Priorities**

- Boot Option # - This feature sets the system boot order of detected devices. The options are **[the list of detected boot device(s)]** and Disabled.

4.8 Save & Exit

Use this menu to configure save and exit settings.

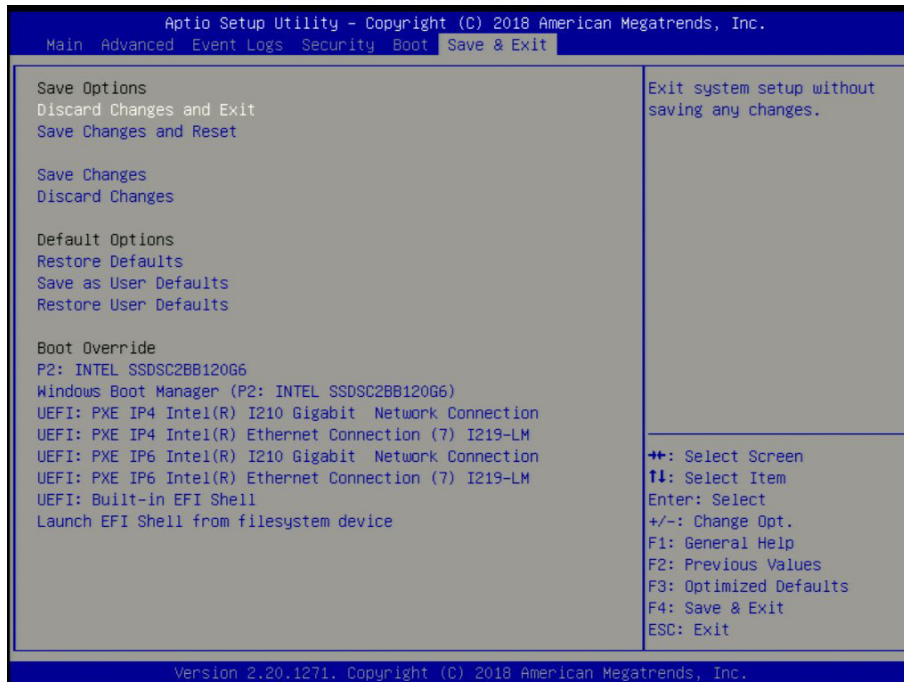

Save Options

Discard Changes and Exit

Select this feature to quit the BIOS Setup without making any permanent changes to the system configuration and reboot the computer. Select Discard Changes and Exit from the Exit menu and press <Enter>.

Save Changes and Reset

When you have completed the system configuration changes, select this option to save all changes made and reset the system.

Save Changes

When you have completed the system configuration changes, select this option to save all changes made. This will not reset (reboot) the system.

Discard Changes

Select this feature and press <Enter> to discard all the changes and return to the AMI BIOS Utility Program.

Default Options

Restore Defaults

To set this feature, select Restore Optimized Defaults and press <Enter>. These are factory settings designed for maximum system performance but not for maximum stability.

Save as User Defaults

To set this feature, select Save as User Defaults from the Exit menu and press <Enter>. This enables the user to save any changes to the BIOS setup for future use.

Restore User Defaults

To set this feature, select Restore User Defaults from the Exit menu and press <Enter>. Use this feature to retrieve user-defined settings that were saved previously.

Boot Override

Other boot options are listed in this section. The system will boot to the selected boot option.

UEFI: Built-in EFI Shell

Launch EFI Shell from filesystem device

Appendix A

BIOS Codes

A.1 BIOS Error POST (Beep) Codes

During the POST (Power-On Self-Test) routines, which are performed each time the system is powered on, errors may occur.

Non-fatal errors are those which, in most cases, allow the system to continue the boot-up process. The error messages normally appear on the screen.

Fatal errors are those which will not allow the system to continue the boot-up procedure. If a fatal error occurs, you should consult with your system manufacturer for possible repairs.

These fatal errors are usually communicated through a series of audible beeps. The table below lists some common errors and their corresponding beep codes encountered by users.

BIOS Beep (POST) Codes		
Beep Code	Error Message	Description
1 beep	Refresh	Circuits have been reset (Ready to power up)
5 short, 1 long	Memory error	No memory detected in system
5 long, 2 short	Display memory read/write error	Video adapter missing or with faulty memory
1 long continuous	System OH	System overheat condition

A.2 Additional BIOS POST Codes

The AMI BIOS supplies additional checkpoint codes, which are documented online at <http://www.supermicro.com/support/manuals/> ("AMI BIOS POST Codes User's Guide").

When BIOS performs the Power On Self Test, it writes checkpoint codes to I/O port 0080h. If the computer cannot complete the boot process, a diagnostic card can be attached to the computer to read I/O port 0080h (Supermicro p/n AOM-SPI80-V).

For information on AMI updates, please refer to <http://www.ami.com/products/>.

Appendix B

Software Installation

B.1 Installing Software Programs

The Supermicro website contains drivers and utilities for your system at <https://www.supermicro.com/wftp/driver>. Some of these must be installed, such as the chipset driver.

After accessing the website, go into the CDR_Images (in the parent directory of the above link) and locate the ISO file for your motherboard. Download this file to create a DVD of the drivers and utilities it contains. (You may also use a utility to extract the ISO file if preferred.)

After creating a DVD with the ISO files, insert the disk into the DVD drive on your system and the display shown in Figure B-1 should appear.

Another option is to go to the Supermicro website at <http://www.supermicro.com/products/>. Find the product page for your motherboard here, where you may download individual drivers and utilities to your hard drive or a USB flash drive and install from there.

 **Note:** To install the Windows operating system, please refer to the instructions posted on our website at <http://www.supermicro.com/support/manuals/>.

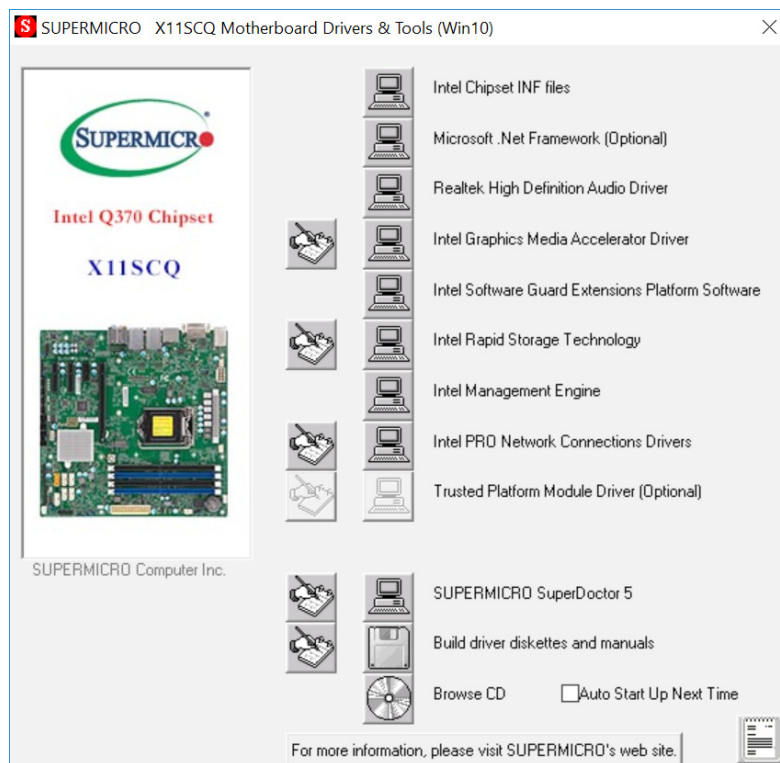

Figure B-1. Driver/Tool Installation Display Screen

Click the icons showing a hand writing on the paper to view the readme files for each item. Click a computer icon to the right of an item to install an item (from top to bottom) one at a time. After installing each item, you must reboot the system before proceeding with the next item on the list. The bottom icon with a DVD on it allows you to view the entire contents of the DVD.

When making a storage driver diskette by booting into a driver DVD, please set the SATA Configuration to "Compatible Mode" and configure SATA as IDE in the BIOS Setup. After making the driver diskette, be sure to change the SATA settings back to your original settings.

B.2 SuperDoctor® 5

The Supermicro SuperDoctor 5 is a hardware monitoring program that functions in a command-line or web-based interface in Windows and Linux operating systems. The program monitors system health information such as CPU temperature, system voltages, system power consumption, fan speed, and provides alerts via email or Simple Network Management Protocol (SNMP).

SuperDoctor 5 comes in local and remote management versions and can be used with Nagios to maximize your system monitoring needs. With SuperDoctor 5 Management Server (SSM Server), you can remotely control power on/off and reset chassis intrusion for multiple systems with SuperDoctor 5 or IPMI. SD5 Management Server monitors HTTP, FTP, and SMTP services to optimize the efficiency of your operation.



Note: The default Username and Password for SuperDoctor 5 is ADMIN / ADMIN.

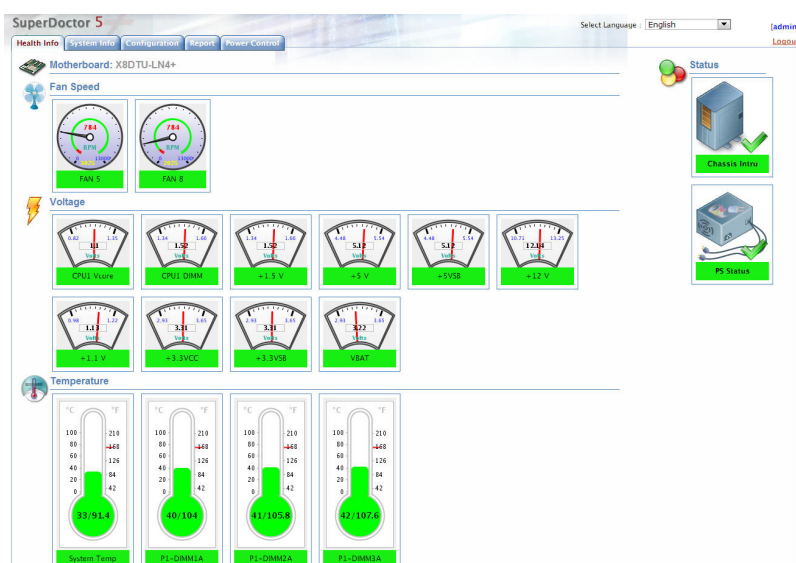

Figure B-2. SuperDoctor 5 Interface Display Screen (Health Information)



Note: The SuperDoctor 5 program and user's manual can be downloaded from the Supermicro website at http://www.supermicro.com/products/nfo/sms_sd5.cfm.

Appendix C

Standardized Warning Statements

The following statements are industry standard warnings, provided to warn the user of situations which have the potential for bodily injury. Should you have questions or experience difficulty, contact Supermicro's Technical Support department for assistance. Only certified technicians should attempt to install or configure components.

Read this section in its entirety before installing or configuring components.

These warnings may also be found on our website at http://www.supermicro.com/about/policies/safety_information.cfm.

Battery Handling



Warning! There is the danger of explosion if the battery is replaced incorrectly. Replace the battery only with the same or equivalent type recommended by the manufacturer. Dispose of used batteries according to the manufacturer's instructions

電池の取り扱い

電池交換が正しく行われなかった場合、破裂の危険性があります。交換する電池はメーカーが推奨する型、または同等のものを使用下さい。使用済電池は製造元の指示に従って処分して下さい。

警告

電池更換不當會有爆炸危險。請只使用同類電池或制造商推薦的功能相當的電池更換原有電池。請按製造商的說明處理廢舊電池。

警告

電池更換不當會有爆炸危險。請使用製造商建議之相同或功能相當的電池更換原有電池。請按照製造商的說明指示處理廢棄舊電池。

Warnung

Bei Einsetzen einer falschen Batterie besteht Explosionsgefahr. Ersetzen Sie die Batterie nur durch den gleichen oder vom Hersteller empfohlenen Batterietyp. Entsorgen Sie die benutzten Batterien nach den Anweisungen des Herstellers.

Attention

Danger d'explosion si la pile n'est pas remplacée correctement. Ne la remplacer que par une pile de type semblable ou équivalent, recommandée par le fabricant. Jeter les piles usagées conformément aux instructions du fabricant.

¡Advertencia!

Existe peligro de explosión si la batería se reemplaza de manera incorrecta. Reemplazar la batería exclusivamente con el mismo tipo o el equivalente recomendado por el fabricante. Desechar las baterías gastadas según las instrucciones del fabricante.

אזהרה!

קיימת סכנת פיצוץ של הסוללה במידה והוחלפה בדרך לא תקינה. יש להחליף את הסוללה בסוג התואם מחברת יצרן מומלצת. סילוק הסוללות המשומשות יש לבצע לפי הוראות היצרן.

هناك خطر من انفجار في حالة اسبدال البطارية بطريقة غير صحيحة فعلياً
اسبدال البطارية
فقط بنفس النوع أو ما يعادلها مما أوصت به الشركة المصنعة
جخلص من البطاريات المسحمة وفقاً لتعليمات الشركة الصانعة

경고!

배터리가 올바르게 교체되지 않으면 폭발의 위험이 있습니다. 기존 배터리와 동일하거나 제조사에서 권장하는 동등한 종류의 배터리로만 교체해야 합니다. 제조사의 안내에 따라 사용된 배터리를 처리하여 주십시오.

Waarschuwing

Er is ontplofingsgevaar indien de batterij verkeerd vervangen wordt. Vervang de batterij slechts met hetzelfde of een equivalent type die door de fabrikant aanbevolen wordt. Gebruikte batterijen dienen overeenkomstig fabrieksvoorschriften afgevoerd te worden.

Product Disposal



Warning! Ultimate disposal of this product should be handled according to all national laws and regulations.

製品の廃棄

この製品を廃棄処分する場合、国の関係する全ての法律・条例に従い処理する必要があります。

警告

本产品的废弃处理应根据所有国家的法律和规章进行。

警告

本產品的廢棄處理應根據所有國家的法律和規章進行。

Warnung

Die Entsorgung dieses Produkts sollte gemäß allen Bestimmungen und Gesetzen des Landes erfolgen.

¡Advertencia!

Al deshacerse por completo de este producto debe seguir todas las leyes y reglamentos nacionales.

Attention

La mise au rebut ou le recyclage de ce produit sont généralement soumis à des lois et/ou directives de respect de l'environnement. Renseignez-vous auprès de l'organisme compétent.

סילוק המוצר

אזהרה!

סילוק סופי של מוצר זה חייב להיות בהתאם להנחיות וחוקי המדינה.

التخلص النهائي من هذا المنتج ينبغي التعامل معه وفقا لجميع القوانين واللوائح الوطنية عند

경고!

이 제품은 해당 국가의 관련 법규 및 규정에 따라 폐기되어야 합니다.

Waarschuwing

De uiteindelijke verwijdering van dit product dient te geschieden in overeenstemming met alle nationale wetten en reglementen.

Appendix D

UEFI BIOS Recovery

Warning: Do not upgrade the BIOS unless your system has a BIOS-related issue. Flashing the wrong BIOS can cause irreparable damage to the system. In no event shall Supermicro be liable for direct, indirect, special, incidental, or consequential damages arising from a BIOS update. If you need to update the BIOS, do not shut down or reset the system while the BIOS is updating to avoid possible boot failure.

D.1 Overview

The Unified Extensible Firmware Interface (UEFI) provides a software-based interface between the operating system and the platform firmware in the pre-boot environment. The UEFI specification supports an architecture-independent mechanism that will allow the UEFI OS loader stored in an add-on card to boot the system. The UEFI offers clean, hands-off management to a computer during system boot.

D.2 Recovering the UEFI BIOS Image

A UEFI BIOS flash chip consists of a recovery BIOS block and a main BIOS block (a main BIOS image). The recovery block contains critical BIOS codes, including memory detection and recovery codes for the user to flash a healthy BIOS image if the original main BIOS image is corrupted. When the system power is first turned on, the boot block codes execute first. Once this process is completed, the main BIOS code will continue with system initialization and the remaining POST (Power-On Self-Test) routines.

 **Note 1:** Follow the BIOS recovery instructions below for BIOS recovery when the main BIOS block crashes.

 **Note 2:** When the BIOS recovery block crashes, you will need to follow the procedures to make a Returned Merchandise Authorization (RMA) request. (For a RMA request, please see section 3.5 for more information).

D.3 Recovering the BIOS Block with a USB Device

This feature allows the user to recover the main BIOS image using a USB-attached device without additional utilities used. A USB flash device such as a USB Flash Drive, or a USB CD/DVD ROM/RW device can be used for this purpose. However, a USB Hard Disk drive cannot be used for BIOS recovery at this time.

The file system supported by the recovery block is FAT (including FAT12, FAT16, and FAT32), which is installed on a bootable or non-bootable USB-attached device. However, the BIOS might need several minutes to locate the SUPER.ROM file if the media size becomes too large due to the huge volumes of folders and files stored in the device.

To perform UEFI BIOS recovery using a USB-attached device, follow the instructions below:

1. Using a different machine, copy the "Super.ROM" binary image file into the disc Root "\\" directory of a USB device or a writable CD/DVD.

 **Note 1:** If you cannot locate the "Super.ROM" file in your driver disk, visit our website at www.supermicro.com to download the BIOS package. Extract the BIOS binary image into a USB flash device and rename it "Super.ROM" for the BIOS recovery use.

 **Note 2:** Before recovering the main BIOS image, confirm that the "Super.ROM" binary image file you download is the same version or a close version meant for your motherboard.

2. Insert the USB device that contains the new BIOS image ("Super.ROM") into your USB port and reset the system until the following screen appears:



- After locating the new BIOS binary image, the system will enter the BIOS Recovery menu as shown below:

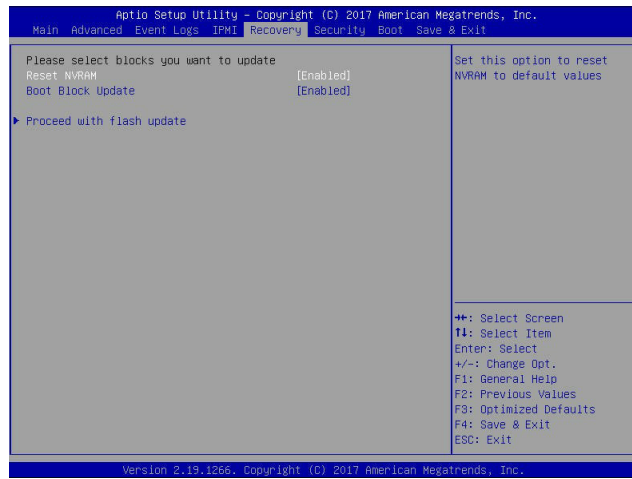

 **Note:** At this point, you may decide if you want to start the BIOS recovery. If you decide to proceed with BIOS recovery, follow the procedures below.

- When the screen as shown above displays, use the arrow keys to select the item "Proceed with flash update" and press the <Enter> key. You will see the BIOS recovery progress as shown in the screen below:

 **Note:** Do not interrupt the BIOS flashing process until it has completed.

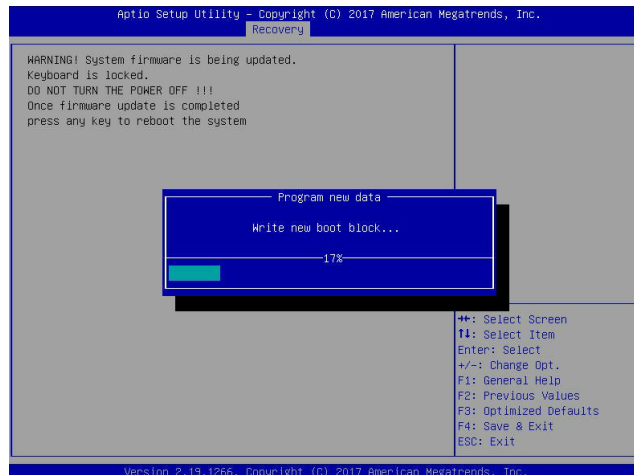

- After the BIOS recovery process is completed, press any key to reboot the system.

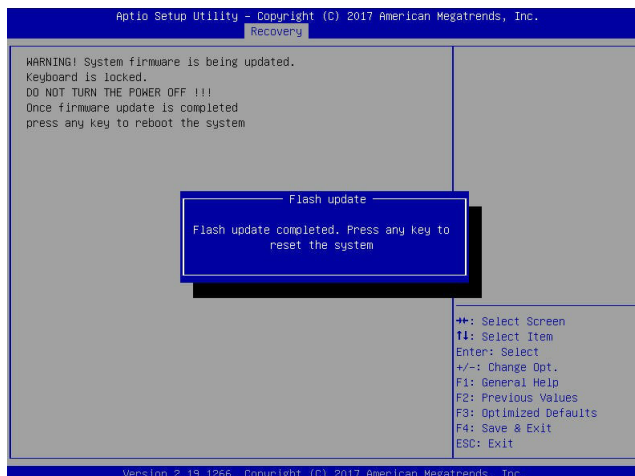

- Using a different system, extract the BIOS package into a USB flash drive.
- Press continuously during system boot to enter the BIOS Setup utility. From the top of the tool bar, select Boot to enter the submenu. From the submenu list, select Boot Option #1 as shown below. Then, set Boot Option #1 to [UEFI AP:UEFI: Built-in EFI Shell]. Press <F4> to save the settings and exit the BIOS Setup utility.

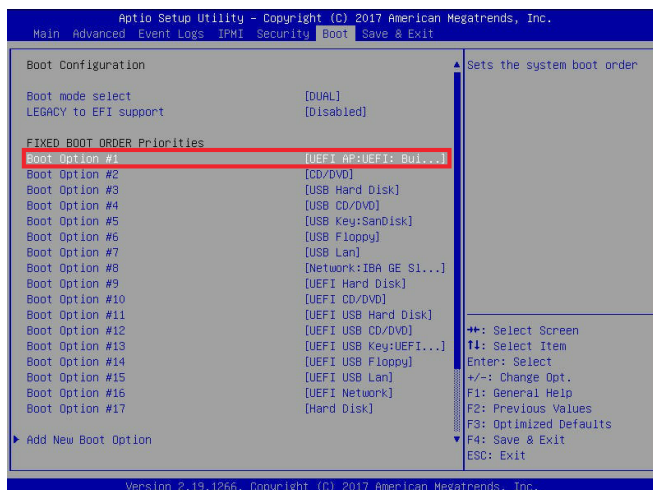

- When the UEFI Shell prompt appears, type `fs#` to change the device directory path. Go to the directory that contains the BIOS package you extracted earlier from Step 6. Enter `flash.nsh BIOSname.###` at the prompt to start the BIOS update process.

```

UEFI Interactive Shell v2.1
EDK II
UEFI v2.50 (American Megatrends, 0x0005000C)
Mapping table
  FS0: Alias(s):HD(0):MBR:BLK1:
        PciRoot(0x0)/Pci(0x14,0x0)/USB(0x11,0x0)/HD(1,MBR,0x3791072,0x800,0x1
DR9592)
  BLK0: Alias(s):
        PciRoot(0x0)/Pci(0x14,0x0)/USB(0x11,0x0)
Press F8 in 1 seconds to skip startup.nsh or any other key to continue.
Shell> fs0:
FS0:\> cd AFUDOS
FS0:\AFUDOS> cd SNIPME2_03162017
FS0:\AFUDOS\SNIPME2_03162017> flash.nsh X110PU7_314
    
```

 **Note:** Do not interrupt this process until the BIOS flashing is complete.

```

Done.
[ Access Cmos Port Ex ]
<Read>
Index 0x51: 0x10

Done.
*****
* Program BIOS and ME (including FDT) regions...
*****
| AMT Firmware Update Utility v5.09.01.1917
| Copyright (C)2017 American Megatrends Inc. All Rights Reserved.
|-----|
CPUID = 50652

Reading flash ..... done
- ME Data Size checking - ok
- FFS checksums ..... ok
- Check RomLayout ..... Ok
Erasing Boot Block ..... done
Updating Boot Block ..... done
Verifying Boot Block ..... done
_Erasing Main Block ..... 0x00132000 (0x)
    
```

- The screen above indicates that the BIOS update process is complete. When you see the screen above, unplug the AC power cable from the power supply, clear CMOS, and plug the AC power cable in the power supply again to power on the system.

```

Verifying MBR Block ..... done
- Update success for FFS
- Update success for IE.
- Successful Update Recovery Loader to GPRx!!
- Successful Update MFSB!!
- Successful Update FTRx!!
- Successful Update MFS, IVB1 and IVB2!!
- Successful Update FLOG and UTOK!!
- ME Entire Image update success !!
WARNING : system must power-off to have the changes take effect!
Moving FS0:\AFUDOS\SNIPME2_03162017\fdt\k64.efi -> FS0:\AFUDOS\SNIPME2_03162017\fdt\k64.efi
dt.smc
- [ok]
Moving FS0:\AFUDOS\SNIPME2_03162017\afuefi\k64.efi -> FS0:\AFUDOS\SNIPME2_03162017\afuefi\k64.efi
7\afuefi.smc
- [ok]
*****
* Please ignore this 'Shell: Cannot read from file - Device Error'
* warning message due to it does not impact flashing process.
*****
Deleting 'FS0:\AFUDOS\SNIPME2_03162017\afuefi\k64.efi'
Delete successful.
FS0:\>
    
```

- Press `` continuously to enter the BIOS Setup utility.
- Press `<F3>` to load the default settings.
- After loading the default settings, press `<F4>` to save the settings and exit the BIOS Setup utility.